

RANS

S-7S COURIER

TEXT MANUAL

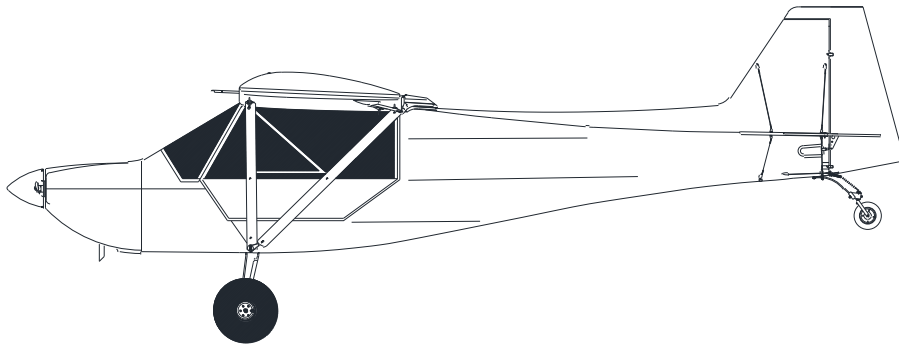

Serial Number:

Registration Number:

COPYRIGHT ©

RANS DESIGNS
4600 HWY 183 Alt
HAYS, KANSAS, USA 67601
785-625-6346
www.rans.com

09/01/2014

AFTER PRINTING THE S-7S MANUAL.

HOW DO I ASSEMBLE THE MANUAL?

1. Obtain three 2" wide 3-ring binders.
2. Place the TEXT, PARTS and FIGURES manuals in separate binders. Every page has a section number then a page number within that section. (Example: parts page 006-02) Parts pages have an exploded view and a parts listing. **NOTE:** *The PARTS manual pages will need to rotate to allow easier viewing. Refer to pages at beginning of PARTS manual.*
3. Separate the sections with the tab inserts listed below.
4. Cut out on solid lines, fold on dotted line, and slip in the labels to corresponding sections. Tabs are designed for 1-1/4 " Insertable Tabs.

| | |
|------------------------------|----------------------------|
| 00 - GENERAL | 08 - COVERING |
| 01 - GENERAL | 09 - COVERING |
| 01 - FUSELAGE SYSTEMS | 09 - SEAT BELTS & INTERIOR |
| 01 - FUSELAGE SYSTEMS | 09 - SEAT BELTS & INTERIOR |
| 02 - CONTROL SYSTEMS | 10 - OPTIONS |
| 02 - CONTROL SYSTEMS | 10 - OPTIONS |
| 03 - ENGINE | 11 - RIGGING |
| 03 - ENGINE | 11 - RIGGING |
| 04 - INSTRUMENT PITOT/STATIC | 12 - WEIGHT & BALANCE |
| 04 - INSTRUMENT PITOT/STATIC | 12 - WEIGHT & BALANCE |
| 05 - WINGS | 13 - OPERATIONS |
| 05 - WINGS | 13 - OPERATIONS |
| 06 - BOOT COWL & PANEL | |
| 06 - BOOT COWL & PANEL | |
| 07 - WINDSHIELD & DOORS | |
| 07 - WINDSHIELD & DOORS | |
| 08 - WINDSHIELD & DOORS | |
| 08 - WINDSHIELD & DOORS | |

| | | |
|-------------------------------------|---------------------------------|---------------------------------------|
| DOORS & WINDSHIELD DOORS | 07 - WINDSHIELD & DOORS | |
| TAN PANEL & BOOT COWL & PANEL | 06 - BOOT COWL & PANEL | |
| SGN/W - 90 | SNOPER - 13 | 13 - OPERATIONS |
| 05 - WINGS | | 13 - OPERATIONS |
| CIT/ST/INSTRUMENT PITOT/STATIC | 04 - INSTRUMENT PITOT/STATIC | 12 - WEIGHT & BALANCE |
| ENGINE - 30 | | ENGINE - 11 |
| 03 - ENGINE | | 11 - RIGGING |
| CONTROL SYSTEMS | 02 - CONTROL SYSTEMS | SNOPER - 01 |
| 02 - CONTROL SYSTEMS | | 10 - OPTIONS |
| SM SYSTEMS FUSELAGE - 10 | 01 - FUSELAGE SYSTEMS | INTERIOR SEAT BELTS & SEAT BELTS - 60 |
| GENERAL | 00 - GENERAL | COVERING - 80 |
| | | COVERING - 80 |

| | | |
|-------------------------------------|---------------------------------|---------------------------------------|
| DOORS & WINDSHIELD DOORS | 07 - WINDSHIELD & DOORS | |
| TAN PANEL & BOOT COWL & PANEL | 06 - BOOT COWL & PANEL | |
| SGN/W - 90 | SNOPER - 13 | 13 - OPERATIONS |
| 05 - WINGS | | 13 - OPERATIONS |
| CIT/ST/INSTRUMENT PITOT/STATIC | 04 - INSTRUMENT PITOT/STATIC | 12 - WEIGHT & BALANCE |
| ENGINE - 30 | | ENGINE - 11 |
| 03 - ENGINE | | 11 - RIGGING |
| CONTROL SYSTEMS | 02 - CONTROL SYSTEMS | SNOPER - 01 |
| 02 - CONTROL SYSTEMS | | 10 - OPTIONS |
| SM SYSTEMS FUSELAGE - 10 | 01 - FUSELAGE SYSTEMS | INTERIOR SEAT BELTS & SEAT BELTS - 60 |
| GENERAL | 00 - GENERAL | COVERING - 80 |
| | | COVERING - 80 |

Labels for the exterior spine of each manual may be made from self-stick labels. The format below may be used.

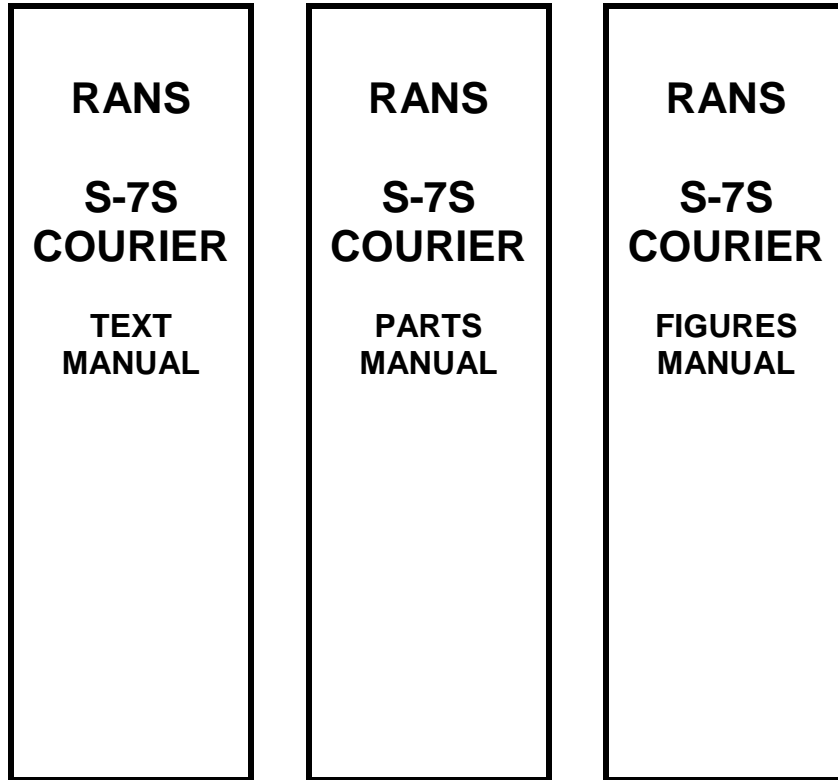

RANS Designs
4600 Highway 183 Alternate
Hays, KS 67601

Technical Support
(785) 625-0069
actech@rans.com

Parts Department
(785) 625-6346
parts@rans.com

When calling Technical Support or Parts Department please have the following ready:

- Aircraft Model
- Serial Number
- Engine Model
- Parts Number Needed (Parts Department Only)
- Your Aircraft Assembly Manuals

NOTE: Please make your questions precise and to the point, so that we may assist as many customers as possible.

RANS AIRCRAFT TECHNICAL SUPPORT

RANS has taken care to provide clear, comprehensive, and straightforward instructions for assembly, maintenance, and operation by reference to manuals alone. In the event a question arises for which no answer seems apparent, feel free to contact RANS headquarters.

Physical and mailing address:.....RANS Designs
4600 Highway 183 Alternate
Hays, KS 67601

Voice:785-625-6346
Fax:785-625-2795
E-mail (General)rans@rans.com
E-mail (Aircraft Tech)actech@rans.com
E-mail (Aircraft Parts)parts@rans.com
Internet site:www.rans.com
Aircraft Technical Support:785-625-0069
Aircraft Parts Department:.....785-625-6346

When calling for parts or technical assistance, have the aircraft model, serial number, engine model number, and assembly manuals at hand.

Questions about propeller care and adjustment and about engine break-in, operation, and maintenance should be directed to respective manufacturer's or supplier's technical support personnel. Refer to manufacturer's or supplier's literature for instructions and contact information.

RANS S-7S Courier

AIRCRAFT TOOL LIST

The following is a list of tools that will be helpful when assembling your RANS aircraft.

HAND TOOLS

| | |
|---|-----------------------------------|
| Pliers | Safety Wire Pliers |
| Needle Nose Pliers | Linesman Pliers |
| Side Cutters | Electrical Wire Stripers Aviation |
| Snips | Pop Rivet Tool |
| Hammer | Click Punch |
| Rubber Mallet* | Ball Peen Hammer |
| Center Punch | Drift Pin & Punch Set Screwdriver |
| Set | Safety Glasses |
| Several Small Clamps (Stanley quick clamps work well) | Wrench Set SAE & Metric |
| Socket Set – SAE & Metric | Ruler & Tape Measure |
| 2 or 4 ft. Level | Utility Knife Hole Saw* |
| Set of Drill Bits (sizes listed below) | Hack Saw |
| Fluting Pliers | Scotch-Brite Pads |
| 1/2" & 3/4" Uni-Bit® Step Drill | Digital Protractor* |
| Pop Grip Dimpler for 1/8" holes | Files |
| Cleco Pliers | Silver #40 Clecos |
| Copper #30 Clecos | Gold #11 Clecos |

POWER TOOLS

| | |
|-------------------------|----------------------------|
| Electric Hand Drill | Small Electric Grinder |
| Dremel* | Bench Disk Sander* |
| Soldering Gun/Hot Knife | Heat Gun* |
| CD/MP3 Player* | Right Angle Drill and Bits |

It is highly recommended to use a pneumatic riveter.
RANS uses these pneumatic riveters.

Marson V2 lightweight pneumatic riveter P/N 79014
MSC Industrial Supply Co. P/N 04053278

LUBRICANTS, ADHESIVES, TAPES & ETC

| | |
|---|--------------------------------|
| Small Can Lithium Grease | Clear Silicone |
| WD40 | Super Glue |
| Lubricating oil | Loctite Blue Threadlocker |
| DOW 730 Sealant or similar | 3M Super 77 Spray Adhesive |
| Thread Sealant | 1/4" wide Double Stick Tape |
| Safety Wire | Hi-Temp Silicone Seal (RED) |
| Clear Plastic Tape (anti-chafe) | 1" Acrylic Foam Tape (2-sided) |
| Adhesive backed Velcro | Masking Tape |
| White Lightning Bike Chain Lube or similar | LORD Fusor 703 Prep/Cleaner |
| LORD Fusor 108B/109B Adhesive, Plunger & Mixer Tips | |

DRILL BIT SIZES

A full set of fractional drill bits ranging from 3/32" to 5/8" is strongly recommended. In addition to these the following number bits will be required to assemble your S-7S Courier.

NUMBERED BITS

#40

#30

#11

#28

#21 & 10-32 TAP

FRACTIONAL BITS

1/4"

5/16"

3/8"

1/2"

7/8"

*Not a necessary tool but helpful

RANS Designs

RECOMMENDED AVIONICS LIST – S-7S

Comm Radios

GARMIN GTR 200

Transponder

GARMIN GTX 335

Encoder

AMERI-KING AK-350

GPS

GARMIN AERA 660

ELT

ACK Technologies E-04

Push to Talk Switch

RADIO SHACK #275-644 Pushbutton Switch

Local Avionic shops can wire your avionic harnesses for you.

Switches, circuit breakers, and other electrical parts are also available from RANS. Contact RANS Parts Department for pricing.

RED Illuminated Master Switch KSES0017

Non-illuminated Switch KSES0016

Panel Post Lights KSES0018

Electrical Buss Bar AMW 636

W58 Circuit Breakers

| | | | |
|--------|----------|--------|---------|
| 1 amp | KSES0010 | 2 amp | KSES001 |
| 4 amp | KSES0014 | 5 amp | KSES001 |
| 10 amp | KSES0013 | 15 amp | KSES001 |

1

S-7S COURIER - GENERAL INFORMATION

INTRODUCTION

As the builder of the S-7S COURIER kit you are considered the manufacturer by law. The rules state that you must build 51% of the total. In essence, we are your parts supplier. You have the final say in regard to every single item that goes into your project. The responsibility of making a safe aircraft is on your shoulders. It is by your hand this box of parts becomes an aircraft. Set up your quality assurance and construction activity according to the level of risk you are willing to take. The manual provided is to be thought of as a suggested guidebook. Use the book, but learn to think things through. This will minimize errors and reduce build time.

BEFORE BEGINNING ASSEMBLY

TAKE INVENTORY:

You must complete an inventory within 60 days of receiving your kit.

We check and re-check and are 99.9% certain that if we say we shipped it, we did. The first task in building your kit is to inventory the parts using the packing list provided. It is your job to keep all parts organized and accounted for. We cannot provide missing parts cost free after 60 days. Use the supplied pack list to verify that everything that we packed is in the box. The fast way to inventory is to use the Priority Number that appears on the Part Number labels, these will match the pack list in numeric order. Go through the list item by item. If anything is not there that should be, please contact our parts department immediately. **HINT:** Use sections of plywood from the packing crate to fabricate a part inventory board. As each part is inventoried and checked off on the pack list, staple the bag to the board. This allows for quick identification and part selection during assembly. We fabricate "A" Frame stands to support the plywood. Refer to **FIGURE 0-01**. Plywood can also be attached to shop walls.

IMPORTANT: When hanging the parts on the board, use the aircraft section designator of the part number to organize the parts. For an explanation of the part number and the meaning of the letters in the prefix refer to **ENGINEERING DEPT. DRAWING NUMBERING SYSTEM**.

ENGINEERING DEPT. DRAWING NUMBERING SYSTEM

RANS TYPICALLY DESIGNATES PARTS BY EIGHT VARIABLES. THIS SYSTEM CONSISTS OF LETTERS AND NUMBERS. THE FOLLOWING IS A BREAK DOWN OF THIS SYSTEM.

X¹X²XX³XXXX⁴

| 1 CLASSIFICATION | 2 DWG TYPE | 3 AIRCRAFT SECTION | 4 ID NUMBER |
|------------------|---|--|-------------|
| K = KIT | A = ASSEMBLY I = INSTALLATION P = PART S = SUPPLIERS V = VIEW | AC = AIRCRAFT AL = AILERON AV = AVIONICS BS = BRAKE SYSTEM CS = CONTROL SYSTEM CV = COVERING CW = COWLING DR = DOOR EL = ELEVATOR EM = EMPENNAGE ES = ELECTRICAL SYSTEM EX = EXHAUST FL = FLAP FS = FUEL SYSTEM FU = FUSELAGE FW = FIREWALL HS = HORIZ. STAB HW = HARDWARE (NOT MS, AN...) IN = INTERIOR IP = INSTRUMENT PANEL JS = JURY STRUT LS = LIFT STRUT MG = MAIN GEAR NG = NOSE GEAR PL = PLACARDS PR = PROPELLER/SPINNER PT = PITOT/STATIC SYSTEM PW = POWER PLANT RD = RUDDER ST = SEAT/HARNESS SY = SYSTEM TG = TAIL GEAR TR = TRIM TAB VS = VERT. STAB. WI = WING WS = WINDSHIELD | 0 - 9999 |

IMPORTANT: PLEASE READ FIRST

PLEASE READ: We highly recommend that you completely read the manual cover to cover before beginning assembly of your aircraft. This will help to eliminate costly mistakes and considerably speed up your build time. As you read through the Assembly Manual, follow along in the Parts and Figure Drawings Manual. Study each and every parts and figure drawing. The Assembly, Parts, and Figure Drawing manuals will parallel each other; however, at times the Assembly manual will use parts from two or more pages of the Parts manual. **PLEASE NOTE:** Unless otherwise noted, all figure and exploded view drawings are **NOT** to scale.

GET ORGANIZED! Prepare your workshop; be certain that what comes in the door will be able to go out!

KEEP IT CLEAN: Wash your hands, tools, and work tables. You will notice most of the parts are labeled with part numbers. These labels are easily removed with a cloth dampened with acetone or lacquer thinner. **CAUTION:** Do not allow Acetone, lacquer thinner, Loctite or fuel to come in contact with the Lexan glazing. These and some other solvents will destroy the Lexan.

STEEL PREPARATION: Even though every care is taken to assure a safe arrival of your aircraft, thoroughly inspect the fuselage as well as all other parts for the following: unclosed welds, nicks, and dents. If you locate any suspect areas with excessive dents or scratches call our Tech-Staff for information on damage tolerance. All Welded steel parts will require primer and top coating. We recommend a good two part epoxy primer. Be sure the primer and paint you choose will not be affected by the urethane adhesive used to bond the fabric to the airframe. Final painting of certain components will be done after trial assembly. Include these components when designing your paint scheme. If you assemble the aircraft in a humid environment it is best to prime everything first.

ASSEMBLY SEQUENCING: We have tried to format the manual in a step by step order as to how to assemble your aircraft. However, there is truly no "one" order in which to follow, as long as the check- lists in the covering section are met prior to covering. If you should choose to build your wings first rather than the fuselage, it is acceptable to do so. **NOTE: It is not necessary to trial fit wings and tail surfaces to the fuselage frame except for the rudder and elevator fit up described in section 1.** It is total acceptable to complete building of the components and then to final install them. Refer to the assembly sequence flow chart at the end of this section.

DEBURRING: Many parts will need to be deburred. This is an IMPORTANT step and must be performed. Assembly of parts with burrs can cause stress risers and eventual part failure. Various tools can be used. A deburring tool is nice but a 1/2" drill bit can do a good job on most holes. Radius and smooth sharp corners with files or fine grit sanders and grinders. Edges of certain parts also need deburring...a good file works here.

CLECOS: These are temporary fasteners that will be used to hold things together while fitting and drilling. A pair of pliers is also required to install and remove the clecos. The cleco's are color coded as to hole size.

| | |
|--------|-----|
| Silver | #40 |
| Copper | #30 |
| Gold | #11 |

To use, simply set cleco in the special pliers, squeeze closed, insert into the hole and release. (Reverse for removal). You will find the clecos to be extremely useful throughout assembly.

ROD ENDS: When installing rod ends and similar hardware, be certain at least ten threads are engaged, unless directed otherwise within the text.

CAUTION: Rod Ends must be engaged a **minimum of 10 complete turns**.

RIVETS: Your kit is supplied with various sizes of aluminum and stainless steel pop rivets. Even though we are careful, there is always the chance of the packages being mis-labeled. So before riveting, be sure to double check that you have the correct aluminum or stainless steel pop rivet for the particular section you are working on.

MARKERS: Throughout the manual, you are instructed to mark on various parts. Use flairs or any type of felt tip marker. Avoid using pencils. The graphite in the lead will cause the aluminum to corrode.

ENGINE WARRANTY: Rotax engines have a six- month warranty from the time of first use. There are however time constraints on this warranty. Please read the following pages on warranty extensions very closely. If there are any questions on engine warranty, please contact the factory.

AN & RIVET CHARTS: All bolts and rivets furnished with the kit are labeled as to their size. In the event they become mixed or you question the size or length of a particular bolt or rivet, we have included an AN bolt chart and a rivet chart.

ORIENTATION: Throughout the Manual, you will be asked to refer to specific stations of the fuselage. Station One (S-1) is the first structural member starting at the nose of the plane. Progressing towards the tail, we pass all stations. Refer to **FIGURE 00-03**.

When a left hand side part is called out, this means the plane's left or your left if you were sitting in the cockpit looking forward.

SERIAL NUMBER: Refer to **FIGURE 00-02** for the serial number location. Please record your serial number and have it handy whenever you call into the factory for assistance.

HAVE FUN: A RANS aircraft is almost as much fun to build as it is to fly and with a little care and planning, your ship could be a show-stopper...Send us and the magazine's pictures of your work in progress or your finished plane.

Send your completion photos to EAA Sport Planes, Experimenter, or Kit Planes. They love to see completed kit planes.

Don't be shy, **SHOW IT OFF!!**

**AS ALWAYS, WE ARE HERE TO HELP!
GIVE US A CALL IF YOU RUN INTO A PROBLEM.**

S-7S ASSEMBLY FLOW CHART – GENERAL

For a general overview refer to the following chart. For more detailed information refer to **ASSEMBLY FLOW CHARTS – DETAILED**. **Note:** The headings in the general chart refer to headings in the detailed flow charts.

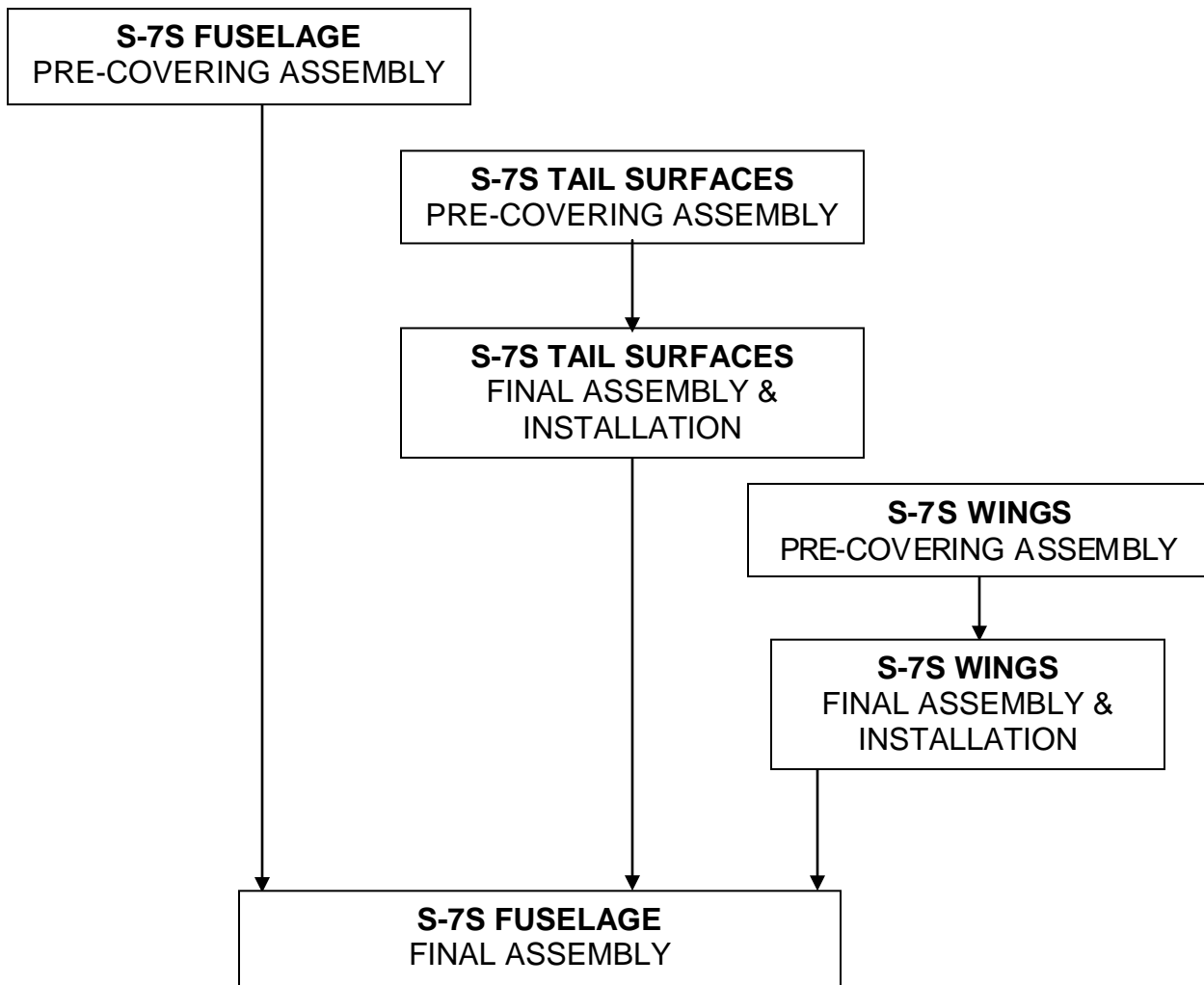

S-7S ASSEMBLY FLOW CHART – DETAILED

Note: The headings in the detailed flow charts on the following pages refer to text manual headings.

S-7S FUSELAGE – PRE-COVERING ASSEMBLY

Refer to Section 1 and complete the following items:

- **RUDDER SYSTEM ASSEMBLY AND INSTALLATION**
 - RUDDER FIT UP
- **PREP AND PRIME FUSELAGE FRAME AND RUDDER FRAME**
- **FUSELAGE FORMER INSTALLATION**
 - VERTICAL STABILIZER FORMER
 - FUSELAGE SIDE FORMER
 - FUSELAGE BOTTOM FORMER
 - RIB VERTICAL STABILIZER
- **MAIN GEAR ASSEMBLY AND INSTALLATION**
 - MAIN GEAR FIT UP
- **FLOORBOARD INSTALLATION**
 - FIT UP
- **RUDDER SYSTEM ASSEMBLY AND INSTALLATION**
 - PRE-COVERING ASSEMBLY
- **DOORFRAME BATTERY ACCESS PANEL INSTALLATION**

Refer to Section 4 and complete the following items:

- **BATTERY BOX ASSEMBLY AND INSTALLATION**
 - BATTERY BOX AND GROUND CABLE
- **ELT AND COMMUNICATION ANTENNA INSTALLATION**
 - ANTENNA MOUNT PLATES

Refer to Section 8 and complete the following items:

- **BAGGAGE COMPARTMENT ASSEMBLY AND INSTALLATION**
- **SEAT BELT ASSEMBLY AND INSTALLATION**
 - AFTER PRIMING OF FUSELAGE FRAME/ BEFORE COVERING



COVERING (Refer to Section 7)



PAINTING (Manual does not provide guidance for painting)



S-7S FUSELAGE – FINAL ASSEMBLY

Refer to Section 1 and complete the following items:

- **MAIN GEAR ASSEMBLY AND INSTALLATION**
 - FINAL INSTALLATION
- **GEAR LEG FAIRING ASSEMBLY AND INSTALLATION**
 - FAIRING FIT UP
 - INSTALLATION
- **TAIL WHEEL ASSEMBLY AND INSTALLATION**

Refer to Section 2 and complete the following items:

- **CONTROL STICK ASSEMBLY AND INSTALLATION**
 - TORQUE TUBE FIT UP
 - FINAL ASSEMBLY AND INSTALLATION
- **ELEVATOR PUSH PULL TUBE ASSEMBLY**

Refer to flow plan section **TAIL SURFACES FINAL ASSEMBLY AND INSTALLATION**

- Complete all items listed.

Refer to Section 2 and complete the following items:

- **FLAP LEVER ASSEMBLY AND INSTALLATION**

Refer to Section 6 and complete the following items:

- **BOOT COWL AND INSTRUMENT PANEL INSTALLATION**
 - BOOT COWL AND INSTRUMENT PANEL FIT UP

Refer to Section 1 and complete the following items:

- **FLOORBOARD INSTALLATION**
 - INSTALLATION
- **RUDDER PEDAL INSTALLATION**
- **FIREWALL ASSEMBLY AND INSTALLATION**
 - ASSEMBLY
 - INSTALLATION
- **HYDRAULIC BRAKE INSTALLATION**
 - AFTER COVERING AND PAINT OF FUSELAGE
- **RUDDER SYSTEM ASSEMBLY AND INSTALLATION**
 - FINAL INSTALLATION

Refer to Section 2 and complete the following items:

- **THROTTLE LEVER INSTALLATION**
- **AILERON CABLE SYSTEM INSTALLATION FUSELAGE**

Refer to Section 3 and complete the following items:

- **FUEL LINE INSTALLATION – FUSELAGE**
 - AFTER COVERING AND PAINT OF FUSELAGE
- **ENGINE MOUNT AND ENGINE INSTALLATION**
- **MUFFLER/ HEATER WRAP ASSEMBLY AND INSTALLATION**
- **LUBRICATION SYSTEM ASSEMBLY AND INSTALLATION**
 - AFTER ENGINE IS INSTALLED
- **COOLING SYSTEM INSTALLATION**
- **FUEL LINE INSTALLATION FIREWALL FORWARD**

Note: To complete the following items it is necessary to clamp the finished instrument panel to the fuselage frame in its approximate position to allow for cable routing and connection. The panel should be in an assembly status allowing it to remain in its position.

- **CARB HEAT INSTALLATION**
- **THROTTLE CABLE AND CHOKE INSTALLATION**
- **HEATER INSTALLATION**

Refer to Section 9 and complete the following items:

- **CARBURETOR HEAT**
- **CABIN HEAT**
- **THROTTLE AND CHOKE**

Refer to Section 1 and complete the following items:

- **HYDRAULIC BRAKE INSTALLATION**
 - AFTER INSTRUMENT PANEL INSTALLATION

Refer to Section 9 and complete the following items:

- **PARK BRAKE**

Refer to Section 4 and complete the following items:

- **BATTERY BOX ASSEMBLY AND INSTALLATION**
 - BATTERY
- **INSTRUMENTS AND ELECTRICAL**

Note: Complete all electrical wiring and check for correct function before installing the boot cowl.

Refer to Section 6 and complete the following items:

- **BOOT COWL AND INSTRUMENT PANEL INSTALLATION**
 - FINAL INSTALLATION

Refer to Section 3 and complete the following items:

- **FUEL LINE INSTALLATION – FUSELAGE**
 - AT BOOT COWL & INSTRUMENT PANEL INSTALLATION

Refer to Section 6 and complete the following items:

- **SPINNER ASSEMBLY AND INSTALLATION**
 - ASSEMBLY
- **PROPELLER INSTALLATION**
- **COWLING ASSEMBLY AND INSTALLATION**
 - ASSEMBLY
- **DOOR ASSEMBLY – LEXAN AND TRIM**
- **DOOR LATCH AND DOOR INSTALLATION**
- **SPINNER ASSEMBLY AND INSTALLATION**
 - INSTALLATION
- **COWLING ASSEMBLY AND INSTALLATION**
 - INSTALLATION

Refer to flow plan section WINGS - FINAL ASSEMBLY & INSTALLATION.

- Complete all items listed after and including WING INSTALLATION.

Refer to Section 6 and complete the following items:

- **WINDSHIELD ASSEMBLY AND INSTALLATION**
 - FIT UP
 - INSTALLATION

Refer to Section 3 and complete the following items:

- **FUEL LINE INSTALLATION – FUSELAGE**
 - AT WINDSHIELD INSTALLATION
 - AFTER INSTALLATION OF WINGS

Refer to Section 8 and complete the following items:

- **SEAT ASSEMBLY AND INSTALLATION**
 - ASSEMBLY
 - INSTALLATION
- **SEAT BELT ASSEMBLY AND INSTALLATION**
 - AFTER COVERING AND PAINT OF FUSELAGE
- **RUDDER CABLE GUARD INSTALLATION**
- **STATION 3 CLOSE OUT INSTALLATION**
- **THROTTLE CABLE COVER INSTALLATION**
- **CONTROL STICK COVER INSTALLATION**

Refer to Section 9 and complete the following items:

- **FUEL SIDE GAUGE CALIBRATION**

Refer to Section 3 and complete the following items:

- **LUBRICATION SYSTEM ASSEMBLY AND INSTALLATION**
 - PRE ENGINE START UP



- **FINAL INSPECTION**

S-7S TAIL SURFACES – PRE-COVERING ASSEMBLY

Refer to Section 1 and complete the following items:

- **HORIZONTAL STABILIZER AND ELEVATOR ASSEMBLY AND INSTALLATION**
 - FIT UP AND PRE-COVERING ASSEMBLY
 - BEFORE PRIMING OF HORIZONTAL STABILIZER AND ELEVATOR FRAMES
- **PREP AND PRIME HORIZONTAL STAB. AND ELEVATOR FRAMES**
 - FIT UP AND PRE-COVERING ASSEMBLY
 - AFTER PRIMING OF HORIZONTAL STABILIZER AND ELEVATOR FRAMES



COVERING (Refer to Section 7)



PAINTING (Manual does not provide guidance for painting)



S-7S TAIL SURFACES – FINAL ASSEMBLY& INSTALLATION

Refer to Section 1 and complete the following items:

- **HORIZONTAL STABILIZER AND ELEVATOR ASSEMBLY AND INSTALLATION**
 - INSTALLATION OF HORIZONTAL STABILIZERS
 - FINAL ASSEMBLY OF ELEVATOR
- **TRIM TAB ASSEMBLY AND INSTALLATION**
 - ASSEMBLY
 - INSTALLATION

Refer to Section 9 and complete the following items:

- **CONTROL SURFACE MASS BALANCE**
 - ELEVATOR

Refer to Section 1 and complete the following items:

- **HORIZONTAL STABILIZER AND ELEVATOR ASSEMBLY AND INSTALLATION**
 - FINAL INSTALLATION OF ELEVATOR

Refer to Section 9 and complete the following items:

- **TAIL SURFACES**
 - TAIL ALIGNMENT AND ROD TENSION
 - ELEVATOR (after elevator control system installation)
 - ELEVATOR TRIM TAB (after trim system installation)
 - RUDDER (after rudder system installation)

S-7S WINGS – PRE-COVERING ASSEMBLY

Refer to Section 5 and complete the following items:

- **WING- MAIN STRUCTURE ASSEMBLY**
 - WING SPAR ASSEMBLY
 - WING FRAME ASSEMBLY
- **FUEL TANK ASSEMBLY AND INSTALLATION**
 - ASSEMBLY
 - INSTALLATION
 - FUEL CAP ASSEMBLY
 - FUEL AND VENT LINE INSTALLATION
- **AILERON BELL CRANK AND CABLE INSTALLATION WING**
- **WING – RIB & SHEET METAL INSTALLATION**
 - WING RIB ASSEMBLY
 - WING RIB INSTALLATION
 - RIB STRINGER INSTALLATION
 - UPPER AND LOWER ROOT SKINS
 - LEADING EDGE TIP WRAP
 - LEADING EDGE WRAP
 - PITOT AND STATIC SYSTEM INSTALLATION
 - FLAP TELEFLEX CABLE INSTALLATION

- **AILERON AND FLAP ASSEMBLY AND INSTALLATION**
 - ASSEMBLY
 - BEFORE COVERING

↓
COVERING (Refer to Section 7)

- **ROOT SKIN INSTALLATION**
 - FIT UP

↓
PAINTING (Manual does not provide guidance for painting)



S-7S WINGS – FINAL ASSEMBLY & INSTALLATION

Refer to Section 5 and complete the following items:

- **AILERON AND FLAP ASSEMBLY AND INSTALLATION**
 - ASSEMBLY
 - AFTER COVERING AND PAINT

Refer to Section 5 and complete the following items:

- **AILERON AND FLAP ASSEMBLY AND INSTALLATION**
 - INSTALLATION
- **WING TIP ASSEMBLY AND INSTALLATION**
 - WING TIP FIT UP AND ASSEMBLY
 - INSTALLATION
- **ROOT SKIN INSTALLATION**
 - INSTALLATION
- **LIFT STRUT ASSEMBLY**
 - INSPECTION OF STRUTS
 - ASSEMBLY
- **FUEL AND VENT LINE INSTALLATION WING**
 - AFTER COVERING AND PAINT OF WINGS
- **WING INSTALLATION**

Refer to Section 2 and complete the following items:

- **AILERON CABLE SYSTEM INSTALLATION FUSELAGE**
 - POST WING INSTALLATION

Refer to Section 9 and complete the following items:

- **WINGS**
 - WING WASHOUT RIGGING
 - AILERON RIGGING
 - FLAP RIGGING

RIVETS CROSS REFERENCE LIST

| DIA. | RANS | | POP RIVET | | | | | | CHERRY Q | | | | | |
|------------|------------|--|-----------|-------|-------|-----------|-----|-------|----------|------|------------|-------|-------|-----------|
| | NO. | | NO. | SHER. | TNSL. | GRIP | NO. | SHER. | TNSL. | GRIP | NO. | SHER. | TNSL. | GRIP |
| 3/32 (#41) | 40APR1/8 | | AD32ABS | 85 | 135 | .031-.125 | -- | -- | -- | -- | AAPO-41 | 225 | 250 | .0-.062 |
| 3/32 (#41) | 40APR1/4 | | AD34ABS | 85 | 135 | .126-.250 | | | | | AAPO-42 | 225 | 250 | .063-.125 |
| 3/32 (#41) | 40APR3/8 | | AD36ABS | 85 | 135 | .251-.375 | | | | | AAPO-44 | 225 | 250 | .126-.250 |
| 1/8 (#30) | 30APR1/16 | | -- | -- | -- | -- | | | | | AAPO-46 | 225 | 250 | .251-.375 |
| 1/8 (#30) | 30APR1/8 | | AD42ABS | 155 | 235 | .063-.125 | | | | | CCPO-41 | 700 | 600 | 0-.062 |
| 1/8 (#30) | 30APR1/4 | | AD44ABS | 155 | 235 | .188-.250 | | | | | CCPO-42 | 700 | 600 | .063-.125 |
| 1/8 (#30) | 30APR3/8 | | AD46ABS | 155 | 235 | .313-.375 | | | | | CCPO-45 | 700 | 600 | .188-.312 |
| 1/8 (#30) | 30SSPR1/16 | | -- | -- | -- | -- | | | | | CCPO-46 | 700 | 600 | .251-.375 |
| 1/8 (#30) | 30SSPR1/8 | | SSD42SSBS | 550 | 700 | .031-.125 | | | | | AAPO-62 | 500 | 450 | .062-.125 |
| 1/8 (#30) | 30SSPR1/4 | | SSD44SSBS | 550 | 700 | .188-.250 | | | | | AAPO-64 | 500 | 450 | .126-.250 |
| 1/8 (#30) | 30SSPR3/8 | | SSD46SSBS | 550 | 700 | .251-.375 | | | | | AAPO-66 | 500 | 450 | .251-.375 |
| 3/16 (#11) | 12APR1/8 | | AD62ABS | 315 | 500 | .063-.125 | | | | | AAPO-68 | 500 | 450 | .376-.500 |
| 3/16 (#11) | 12APR1/4 | | AD64ABS | 315 | 500 | .126-.250 | | | | | CCPO-62 | 1650 | 1300 | .062-.125 |
| 3/16 (#11) | 12APR3/8 | | -- | -- | -- | -- | | | | | CCPO-64 | 1650 | 1300 | .126-.250 |
| 3/16 (#11) | 12APR1/2 | | AD68ABS | 315 | 500 | .375-.500 | | | | | CCPO-66 | 1650 | 1300 | .251-.375 |
| 3/16 (#11) | 12SSPR1/8 | | -- | -- | -- | -- | | | | | SSPQ-68 | 1050 | 825 | .376-.50 |
| 3/16 (#11) | 12SSPR1/4 | | SSD64SSBS | 1000 | 1375 | .126-.250 | | | | | SSPQ-610 | 1050 | 825 | .501-.562 |
| 3/16 (#11) | 12SSPR3/8 | | SSD66SSBS | 1000 | 1375 | .251-.375 | | | | | CCPO-44 | 700 | 600 | .126-.250 |
| 3/16 (#11) | -- | | -- | -- | -- | -- | | | | | AVEX RIVET | | | |
| 3/16 (#11) | -- | | -- | -- | -- | -- | | | | | 1691-0410 | 165 | 230 | .031-.187 |
| 1/8 (#30) | -- | | -- | -- | -- | -- | | | | | | | | |

AN3 - AN8 AIRFRAME BOLTS

AN3-AN8 CADMIUM-PLATED STEEL BOLTS (DRILLED AND UNDRILLED)

A non-corrosion-resistant steel machine bolt which conforms to Specification MIL-B-6812. Cadmium-plated to Specification QQ-P-416.

Available with or without single hole through shank and/or single hole through head. Examples of part members for a cadmium plated steel bolt having a diameter of 1/4" and nominal length of 1".

- AN4-6 For drilled shank
- AN4-6A Designates undrilled shank
- AN4H-6 Drilled head, drilled shank
- AN4H-6A Drilled head, undrilled shank

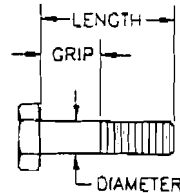

NUT AND COTTER PIN SIZES

| AN NUMBER | DIAMETER | PLAIN NUT AN NUMBER | CASTLE NUT AN NUMBER | COTTER PIN MS NUMBER |
|-----------|----------|---------------------|----------------------|----------------------|
| AN3 | 3/16 | AN315-3R | AN310-3 | MS24665-132 |
| AN4 | 1/4 | AN315-4R | AN310-4 | MS24665-132 |
| AN5 | 5/16 | AN315-5R | AN310-5 | MS24665-132 |
| AN6 | 3/8 | AN315-6R | AN310-6 | MS24665-283 |
| AN7 | 7/16 | AN315-7R | AN310-7 | MS24665-283 |
| AN8 | 1/2 | AN315-8R | AN310-8 | MS24665-283 |

HOW TO DETERMINE GRIP For Steel and Aluminum Aircraft Bolts (Subtract Fractions Shown Below From Length of Bolt)

| AN 3 to AN 8 | AN NUMBER, Diameter, and Threads per inch | AN3 10 -32 | AN4 1/4 -28 | AN5 5/16 -24 | AN6 3/8 -24 | AN7 7/16 -20 | AN8 1/2 -20 |
|--------------|---|---------------|----------------|-----------------|----------------|-----------------|----------------|
| | Grip = Length Less | 13/32 | 15/32* | 17/32 | 41/64 | 21/32 | 25/32 |

*Formula does not apply for AN4-3. Grip for AN4-3 is 1/16.

DASH NUMBER -- NOMINAL LENGTH

| | | | | | | |
|--------------|--------------|-----------------|-----------------|-----------------|-----------------|-----------------|
| -3 . . . 3/8 | -6 . . . 3/4 | -11 . . . 1 1/2 | -14 . . . 1 1/4 | -17 . . . 1 7/8 | -22 . . . 2 1/4 | -25 . . . 2 5/8 |
| -4 . . . 1/2 | -7 . . . 7/8 | -12 . . . 1 1/4 | -15 . . . 1 5/8 | -20 . . . 2 | -23 . . . 2 3/8 | -26 . . . 2 3/4 |
| -5 . . . 5/8 | -10 . . . 1 | -13 . . . 1 3/8 | -16 . . . 1 3/4 | -21 . . . 2 1/8 | -24 . . . 2 1/2 | -27 . . . 2 7/8 |
| | | | | | | -30 . . . 3 |

PART IDENTIFICATION

Use the above chart to determine lengths of bolts. Diameters are as follows:

AN3 = 3/16" AN4 = 1/4" AN5 = 5/16" AN6 = 3/8"

Use the parts manual for other part identification. The drawings depict a fairly accurate likeness of the real thing. Other parts are labeled by part number. Again, reference the parts manual to confirm part identity.

AN BOLT GAUGE

| | | | | | | | |
|------|------|------|------|------|------|------|------|
| — 3 | — 3 | — 4 | — 5 | — 5 | — 6 | — 6 | — 7 |
| — 4 | — 4 | — 5 | — 6 | — 6 | — 7 | — 7 | — 8 |
| — 5 | — 5 | — 6 | — 7 | — 7 | — 8 | — 8 | — 9 |
| — 6 | — 6 | — 7 | — 8 | — 8 | — 9 | — 9 | — 10 |
| — 7 | — 7 | — 8 | — 9 | — 9 | — 10 | — 10 | — 11 |
| — 10 | — 10 | — 11 | — 12 | — 12 | — 13 | — 13 | — 14 |
| — 11 | — 11 | — 12 | — 13 | — 13 | — 14 | — 14 | — 15 |
| — 12 | — 12 | — 13 | — 14 | — 14 | — 15 | — 15 | — 16 |
| — 13 | — 13 | — 14 | — 15 | — 15 | — 16 | — 16 | — 17 |
| — 14 | — 14 | — 15 | — 16 | — 16 | — 17 | — 17 | — 18 |
| — 15 | — 15 | — 16 | — 17 | — 17 | — 18 | — 18 | — 19 |
| — 16 | — 16 | — 17 | — 18 | — 18 | — 19 | — 19 | — 20 |
| — 17 | — 17 | — 18 | — 19 | — 19 | — 20 | — 20 | — 21 |
| — 20 | — 20 | — 21 | — 22 | — 22 | — 23 | — 23 | — 24 |
| — 21 | — 21 | — 22 | — 23 | — 23 | — 24 | — 24 | — 25 |
| — 22 | — 22 | — 23 | — 24 | — 24 | — 25 | — 25 | — 26 |
| — 23 | — 23 | — 24 | — 25 | — 25 | — 26 | — 26 | — 27 |
| — 24 | — 24 | — 25 | — 26 | — 26 | — 27 | — 27 | — 28 |
| — 25 | — 25 | — 26 | — 27 | — 27 | — 28 | — 28 | — 29 |
| — 26 | — 26 | — 27 | — 28 | — 28 | — 29 | — 29 | — 30 |
| — 27 | — 27 | — 28 | — 29 | — 29 | — 30 | — 30 | — 31 |
| — 30 | — 30 | — 31 | — 32 | — 32 | — 33 | — 33 | — 34 |
| — 31 | — 31 | — 32 | — 33 | — 33 | — 34 | — 34 | — 35 |
| — 32 | — 32 | — 33 | — 34 | — 34 | — 35 | — 35 | — 36 |
| — 33 | — 33 | — 34 | — 35 | — 35 | — 36 | — 36 | — 37 |
| — 34 | — 34 | — 35 | — 36 | — 36 | — 37 | — 37 | — 38 |
| — 35 | — 35 | — 36 | — 37 | — 37 | — 38 | — 38 | — 39 |
| — 36 | — 36 | — 37 | — 38 | — 38 | — 39 | — 39 | — 40 |
| — 37 | — 37 | — 38 | — 39 | — 39 | — 40 | — 40 | — 41 |
| — 40 | — 40 | — 41 | — 42 | — 42 | — 43 | — 43 | — 44 |
| — 41 | — 41 | — 42 | — 43 | — 43 | — 44 | — 44 | — 45 |
| — 42 | — 42 | — 43 | — 44 | — 44 | — 45 | — 45 | — 46 |
| — 43 | — 43 | — 44 | — 45 | — 45 | — 46 | — 46 | — 47 |
| — 44 | — 44 | — 45 | — 46 | — 46 | — 47 | — 47 | — 48 |
| — 45 | — 45 | — 46 | — 47 | — 47 | — 48 | — 48 | — 49 |
| — 46 | — 46 | — 47 | — 48 | — 48 | — 49 | — 49 | — 50 |
| — 47 | — 47 | — 48 | — 49 | — 49 | — 50 | — 50 | |
| — 50 | — 50 | — 50 | — 50 | — 50 | — 50 | — 50 | |
| AN3 | AN4 | AN5 | AN6 | AN7 | AN8 | AN9 | AN10 |
| 3/16 | 1/4 | 5/16 | 3/8 | 7/16 | 1/2 | 9/16 | 5/8 |

CLECO SIZES AND QUANTITY

| QUANTITY | SIZE |
|----------|----------------------|
| 12 | NO. 40 SILVER (3/32) |
| 24 | NO. 30 COPPER (1/8) |
| 6 | NO. 11 GOLD (3/16) |

S-7S FUSELAGE FORMER INSTALLATION

NOTE: All fuselage formers must be cut to exact length from raw stock provided. Mark and check fit carefully before cutting. In addition, pay attention to the wall thickness of the raw stock called out in the parts manual. Formers are fabricated from 0.028" wall tubing.

The fuselage frame should be primed before formers or anything else is installed.

VERTICAL STABILIZER FORMER

(AFTER PRIMING OF FUSELAGE FRAME/ BEFORE COVERING)

1. Install the vertical stabilizer former (top of fuselage) onto the fuselage by slipping one end of the former over the stub extending from the vertical stabilizer. Refer to **FIGURE 01-01**. With a friend's help bow the former and slip the other end on top of the tab located on the aft side of station 3. Bow the former downward to touch the vertical attach tubes on stations 4, 5 and 6.
2. Mark the location of the tubes where they contact the former centerline. Remove the former and drill 1/4" holes at these locations through the bottom side of the former only.
3. Re-install the former, the support tubes will slide into the former and bottom out against the top wall. It may be necessary to slightly bend the support tubes into alignment. Trim the forward end of the former to allow to rest on top of the fuselage tab.
4. Locate and drill #40 holes through each support tube just below the former. Locate and drill #40 holes through the former just forward or aft of each support tube.
5. Hold the former tight against the support tubes and safety wire through the hole pairs to retain former position.
6. Drill a #30 hole through the forward end of former and fuselage tab and the aft end of former and vertical stabilizer stub. Refer to **FIGURE 01-01**.
7. Rivet each former end using a stainless steel rivet as shown in **FIGURE 01-01**.

FUSELAGE SIDE FORMER

(AFTER PRIMING OF FUSELAGE FRAME/ BEFORE COVERING)

8. Each fuselage side uses 3 formers to support the fabric. Refer to **FIGURE 01-08** for the proper location of each side former. Determine the length of each former, mark and check fit before cutting from provided raw stock. Note that there are two different diameters of formers (1/4"and 1/2").
9. Start with the **lower aft side formers**. These are made from 1/4" tubing and are retained by a set of welded stubs that the formers will slip over. With the 1/4" formers cut to length, slightly bow the former to allow it to slide over the retaining stubs. It may be necessary to drill out the ends of the former to allow it to slip over the stubs.
10. Drill a # 40 hole through the former just beside the fuselage tube at station 3 as shown in **FIGURE 01-08**.
11. Add anti-chafe tape around the fuselage frame and safety wire former in place.
12. The **upper and center aft side formers** are fabricated from 1/2" diameter tubing. Both formers are attached with rivets from the inside of the fuselage through welded attach tangs. Refer to **FIGURE 01-08**. **NOTE:** *Both formers are spaced at station 4 with plastic washers. You should use as many washers as needed to achieve a smooth flow of the former. Typically 3 to 4 washers will be required.*
13. Fit, mark, check and cut the formers to length. Drill to attach tangs, cleco, deburr and rivet. Do not forget the spacer washers.

FUSELAGE BOTTOM FORMER

(AFTER PRIMING OF FUSELAGE FRAME/ BEFORE COVERING)

14. The **bottom former** is made from 1/2" diameter raw stock tubing. Refer to **FIGURE 01-14**. It is routed along the fuselage bottom center from the main gear truss back to station 4.
15. Fit, mark, check and cut to length. Add anti-chafe tape around the fuselage frame. Locate and drill #40 holes through the former. Refer back to **FIGURE 01-14**. Drill, rivet, and safety wire in place as shown.

RIB VERTICAL STABILIZER

(AFTER PRIMING OF FUSELAGE FRAME/ BEFORE COVERING)

16. The vertical stabilizer receives 1 rib formed from aluminum sheet for fabric support. The forming process leaves the rib slightly bowed. To straighten the rib, use fluting pliers and crimp the rib flanges slightly between the holes at the notch locations.
17. The rib is mounted on top of the vertical stabilizer frame cross brace and is riveted from the topside to the 3 welded tangs. Refer to **FIGURE 01-17**. **NOTE:** *the rib is symmetrical. There is no front or aft.* The flanges of the ribs are down. Some minor trimming might be required for a perfect fit around the stabilizer spars.
18. Deburr rib, fit, and transfer drill # 30 through tangs and rivet in place.

S-7S MAIN GEAR ASSEMBLY AND INSTALLATION

MAIN GEAR FIT UP

NOTE: Please be sure to refer to parts page when installing. Fuselage should be covered and painted before final installation.

1. Become familiar with the Main Gear Installation Parts Drawings and collect the parts shown in the drawing.
2. Examine your Gear Legs. They are glass beaded to relieve stresses from machining and bending. If your inspection reveals any gouges or scratches, polish or sand to remove.
3. Support the fuselage on sturdy sawhorses
4. Install the landing gear using the hardware shown in the Parts Drawings.
5. Top Main Gear Clamp Plate should be orientated per **FIGURE 01A-05**. Be sure the Top Main Gear Clamp Plate fits tight against the Fuselage Longeron. File upper side of clamp plate if required.
6. If any movement is evident where the Clamp Plates intersect the Gear Legs, use a file to remove material from the Landing Gear Spacer Bushings until the movement is eliminated. **IMPORTANT:** Be sure to install Anti-chafe Strip between Gear Leg and Bottom Clamp Plate.

IMPORTANT
TORQUE MAIN GEAR MOUNTING BOLTS TO THE FOLLOWING:

AN5 = 140 INCH-POUNDS
AN6 = 190 INCH-POUNDS

7. It is recommended to paint the Gear Legs and Clamp Plates.

!!! CAUTION !!!
Do **NOT** Powder Coat or Heat-Treat Gear Legs.
Doing so may remove required temper and strength.

8. Final install Gear Legs after covering and painting Fuselage.

MAIN GEAR WHEEL/BRAKE INSTALLATION

9. Become familiar with the Main Gear Wheel/Brake Installation **Parts Drawings** and collect the parts shown in the drawings.
10. Bolt caliper mount, and axle to the gear leg assembly as per parts drawing. Assemble the wheel and brake kit as per parts manual and manufacturer's instructions. With the aircraft in a level attitude, the brake assembly will be orientated to the aft and down. The tire pressure should be approximately 20 psi. To install the wheel assembly, the outer brake pad removes via the 1/4" retainer bolts.
11. Clean and pack the tapered wheel bearings. The tapered roller bearings are oiled from the factory for rust prevention, but not greased. The roller bearings should be cleaned, dried, and then packed with suitable grease. Packing grease without first removing the oil will dilute the wheel grease, causing it to run out past the seal and not lubricate properly.
12. Slip the bearings and wheel / tire assembly back onto the axle. Install the washer and castle nut. Tighten the castle nut to manufactures specifications or bearing failure may result. Secure with the large cotter pin.

IMPORTANT INFORMATION:

MATCO Mfg wheels using tapered roller bearings are equipped with Timken bearings utilizing integrated grease seals on the bearing cone to ensure the longest possible life. The torqueing procedure for bearings with these type seals is different than for tapered roller bearings without them. A common torqueing technique for bearings *without integrated seals* is to tighten the axle nut until the wheel stops spinning freely and then back off to the nearest locking feature. **THIS TECHNIQUE WILL NOT WORK ON A BEARING WITH AN INTEGRATED SEAL.** The reason for a different torqueing technique is that the grease seal produces some drag and makes the wheel feel somewhat stiff when rotated. Reducing the axle nut torque until the wheel spins freely will allow the grease seal and the bearing cone to improperly rotate with the wheel (the cone must not rotate relative to the axle). The higher rolling drag is completely normal for this bearing and allows for longer bearing life since the seal will keep most contaminants out. Timken specification state, for example, that the two 1.25 inch tapered roller bearing used on the WE51 will produce 18-26 inch pounds of torque (drag) when properly installed. A light coating of grease on the seal will help reduce the drag on initial installation. The drag will also reduce after the bearings have been installed and the seal relaxes in the bore. It is important that the axle nut torque be sufficient to keep the seal from rotating with the wheel. With the bearings cleaned, dried, greased, and inserted in the wheel, the axle nut should be tightened until all play is out of the assembly. Rotate the wheel back and forth while tightening the nut to help seat the bearings. When all play is out of the assembly, and the wheel rotates freely, tighten to the next castle slot and insert the cotter pin. The rubber seal on the tapered roller bearing will remain stationary while the wheel rotates around it. If the seal is spinning on the axle, the nut should be tightened further until the seal stops spinning with the wheel.

13. Apply Thread Sealant to the threads of the brake fitting and install the fitting into the caliper. The fitting should face upward.

FINAL ASSEMBLY

14. Install D-Cell Rubber Seal to bottom side of Station 2 crossing tube to help seal against Gear Legs and Boot Cowl. **NOTE:** *Install D-Cell to inboard side of Top Clamp Plate. Do **NOT** place between Clamp Plate and Fuselage.*
15. Install Main Gear to Fuselage
16. During Final Assembly, route the brake lines from the Fuselage bulkhead fitting, down the Gear Leg, to the Brake Assembly. **NOTE:** *The brake line will press into the groove machined into the aft side of the Gear Leg.*

S-7S TAIL WHEEL ASSEMBLY AND INSTALLATION

(AFTER COVERING AND PAINT OF FUSELAGE)

1. Bolt the tail spring to the tail wheel assembly. Refer to the parts drawing. **NOTE:** *It may be necessary to lightly file or grind the tail spring to fit within the spring mount channel. **IMPORTANT:** Do **NOT** modify the channel to obtain the proper fit as rotation of the tail wheel swivel block may occur, producing poor directional control.*
2. Bolt the tail spring/ tail wheel assembly to the fuselage as per parts drawing. Refer to **FIGURE 01B-02**. **IMPORTANT:** *Be sure the crown of each Gear Strap is oriented toward the tail spring.*
3. Fabricate 2 small spacer bushings from raw stock provided as shown in the parts manual.
4. The two Attach Tangs bolted to the Pillow Block Strap must be modified before bolted in place. For parts callout and modification of these tangs refer to **HORIZONTAL STABILIZER & ELEVATOR ASSEMBLY & INSTALLATION**. It is also possible to only finger tighten these two bolts and to attach the tangs later, when the tail is installed.
5. During final assembly, it is important that all bolts retaining the tail spring are tight. Check the tightness of these bolts after the first 10 hours of flying. **IMPORTANT:** *There must also be a minimum clearance of 1/4" between the tail spring and the bottom edge of the rudder spar.* Refer to **RUDDER SYSTEM ASSEMBLY & INSTALLATION** for instructions on installing the rudder. If there is not sufficient clearance, space the tail spring away until the minimum clearance is obtained. This is done by the addition of an aluminum plate between the tail spring and the fuselage. Longer bolts may be required to do this.
6. Install the control linkage as per the exploded view drawing. The linkage will be attached to only the tail wheel at this time. Refer to the **RUDDER SYSTEM ASSEMBLY & INSTALLATION** for final assembly and adjustment of the linkage.
7. The tail wheel is full swivel. This allows pivot turns using brakes or full rudder deflection. A cam mechanism allows it to engage for steering. **IMPORTANT:** *If the tail wheel leans, shim the tail wheel to run vertical.*

S-7S HORIZONTAL STABILIZER AND ELEVATOR ASSEMBLY AND INSTALLATION

FIT-UP AND PRE-COVERING ASSEMBLY

(BEFORE PRIMING OF HORIZONTAL STABILIZER AND ELEVATOR FRAMES)

1. The elevator hinges must be secured in position. Temporarily bolt the elevators to the horizontal stabilizers. **NOTE:** *There are left and right stabilizers and elevators.* The stabilizers have bushings for fuselage attachment. These bushings are on the upper side of the frame. The right elevator is identified by the trim tab hinges and the 3 welded tangs (trim servo attach). Refer to **FIGURE 01C-01**.
2. Adjust elevator left and right to create a 3/16" to 1/4" gap between the tip of the horizontal stabilizer and the overhang of the elevator.
3. With the elevator correctly positioned, slide each retaining collar against the hinges. Position the retaining collars to allow the hinge to swivel freely with minimal play.
4. Locate and drill a # 30 hole on the interior side of each retaining collar through the leading edge spar of the elevator.
5. Rivet in position as per parts manual and disassemble elevators from horizontal stabs.
6. Mark and drill the aft hole for the elevator horn attach on both elevators. Refer to **FIGURE 01C-01**. Temporarily bolt the control horn to the forward attach hole already drilled at the factory and use it to mark the aft hole location on the centerline of the tube. Take horn off and drill both elevators # 11.
7. Prep and prime horizontal stabilizer and elevator frames.

(AFTER PRIMING OF HORIZONTAL STABILIZER AND ELEVATOR FRAMES)

Refer to **FIGURE 01-11**

8. Install the nut plates to the elevator horn attach holes on both elevators. Refer to parts page.
9. Each horizontal stabilizer receives two ribs formed from aluminum sheet to support the fabric. The forming process leaves the ribs slightly bowed.
10. Use fluting pliers and crimp the rib flanges slightly between the holes at the notch locations to straighten ribs.
11. The ribs are riveted to the frame via welded tangs. Refer to **FIGURE 01C-11**. **NOTE:** *The ribs are symmetrical. There is no front or aft.*
12. Deburr ribs, orientate as per **FIGURE 01C-11**, and transfer drill through tangs and rivet in place.
13. Elevator and horizontal stabilizer are now ready for covering. Refer to **COVERING** for instructions.

INSTALLATION OF HORIZONTAL STABILIZERS

(AFTER COVERING AND PAINT OF HORIZONTAL STABILIZER)

14. Use a hot iron to burn holes through the fabric at the attach points for the tail bracing, the elevator hinges, and the drain holes. Also, burn through the aft side of the seaplane grommet on the right horizontal stabilizer.
15. Modify 14 attach tangs as per **FIGURE 01C-15**. Use the 1:1 drawings to layout the bends. The dimensions are not that critical, but try to get close. However, the radius is important. We suggest the use of a block with a radius. Clamp block, and tang in a vise. Use a light hammer to form the tang. Take precautions against tooling marks. Mark tangs for identification.
16. Bolt the tangs to the corresponding position on vertical stabilizer, horizontal stabilizers, and fuselage. Refer to **FIGURE 01C-16**. Do **NOT** forget the washers.

17. The tail brace rods are made from stainless steel rod and are reduced in diameter toward the threaded ends. The transition area should extend over approximate 1" to 1.5" and must be smooth. If this area is **NOT** smooth, then modify the tail brace rods as shown in **FIGURE 01C-17**. The setup in **FIGURE 01C-17** makes the task of filing and polishing easy and quick. When clamping the rod in the drill, use some plastic or tape around the end to protect the threads. Use a fine file first and polish afterwards using Scotch-Brite or fine wet/dry paper. Do not worry the rods are plenty strong.
18. Install the aluminum bushings into the stabilizer attach bushings on the fuselage top longerons. See **FIGURE 01C-18**.
19. Attach the stabilizer to the fuselage using the hardware shown in the parts manual. It may be necessary to hold the stabilizer in a vertical position to obtain hole alignment. Install cotter pins.
20. Support the stabilizer in horizontal position. Attach jam nuts and tie rod ends to tail brace rods. Refer to **FIGURE 01C-20**. **NOTE:** *The tail brace rods have on one end LH and on the other end RH threads. There are also tie rod ends with LH and RH threads. Assemble accordingly. The LH and RH threads will make tension adjustment possible without disassembly.*
21. Turn rods all the way into the rod ends. This will assure even thread engagement at both ends when the rods are turned for final tension adjustment. **IMPORTANT:** *For rod tension or length adjustment always turn the rod and keep both ends fixed. That will assure even thread engagement on both ends.*
22. Attach the pre-assembled rods with clevis pins and cotter pins in the appropriate positions as per parts manual. When you do so, adjust the tension of the upper rods so that the lower rods do not bend.
23. For final adjustment, refer to **RIGGING**.

FINAL ASSEMBLY OF ELEVATOR

(AFTER COVERING AND PAINT OF ELEVATOR)

24. Use a hot iron or soldering iron and burn holes through drain grommets, elevator horn attach holes, holes for the mass balance weight attach at the elevator tips, and the 3 servo attach holes on top of the right elevator (through welded tangs).
25. Cut out the fabric inside the trim exit ring on the bottom side of the right elevator using a sharp blade or utility knife.
26. Attach both elevator horns to the elevators as per parts manual. For orientation of horns, refer back to **FIGURE 01C-01**. **NOTE:** *The lower hole of the horns must be drilled out to 1/4" (tight fit).*
27. Install the trim servo in the right elevator. The servo is mounted by 3 screws. The screws enter the elevator from the topside through the covering.
28. Trim the trim exit cover (thermal formed fairing) to fit the glued on exit ring.
29. Drill #40 through the 13 dimpled hole locations in the exit fairing.
30. Place the exit fairing centered on top of the exit ring. Refer to **FIGURE 01C-30** for fairing orientation. Check for clearance to servo and transfer drill # 40 through the exit ring. Cleco as you go.
31. Remove fairing and drill out holes in fairing only to # 30.
32. After the trim tab is installed, you will have to make a slot for the push rod and a small hole for the wiring in the fairing.
33. At this point, install the trim tab. Refer to **TRIM TAB ASSEMBLY AND INSTALLATION** for instructions.
34. After the trim tab is installed, modify the exit fairing to allow for the servo push rod travel. Refer back to **FIGURE 01C-30** and the template on **FIGURE 01C-34**. Elongate the slot as needed.
35. Locate and drill a hole for the trim wiring and slot fairing for easy removal without the need for wiring disconnection. Refer back to **FIGURE 01C-30**.
36. Check that the exit allows for full servo travel. **NOTE:** The servo arm runs through the servo. As the front end retracts, the aft end extends out of the servo. Both sides need clearance. File exit ring if needed.
37. Install fairing with proper hardware and rubber grommet in fairing wire exit.
38. Do **NOT** install elevators to horizontal stabilizers at this time.
39. Both elevators are now ready for static mass balancing. For instructions, refer to **RIGGING**.

FINAL INSTALLATION OF ELEVATOR**(AFTER COVERING, PAINT, ASSEMBLY AND MASS BALANCE OF ELEVATOR)**

40. Bolt both elevators at their hinge points to the corresponding horizontal stabilizer.
41. Lubricate hinge points and check for free movement without binding or excessive friction.
42. Connect elevators to elevator yoke as per parts manual. **IMPORTANT:** *Make sure the rod ends are at least 10 full threads engaged into the elevator yoke.*
43. Check deflection of elevator and trim tab. For instructions, refer to **RIGGING**.

S-7S TRIM TAB ASSEMBLY AND INSTALLATION

ASSEMBLY

(BEFORE PAINT OF TAB)

1. Cleco each trim tab half together along the leading edge. Place the each half on a flat surface and clamp or weigh them down. This will assure that the tab is straight.
2. Remove one cleco at the time, drill out to # 30 and rivet the leading edge.
3. Rivet a single-ear nut plate to each end rib.
4. Install the end ribs into each trim tab half. **IMPORTANT:** *Position each end rib as far forward in the tab as possible and flush with the end.* Prior to drilling, note that there are two sizes of rivets used in each end rib. Refer to **FIGURE 01D-04** and the parts manual.
5. Using the correct size drill bit, and using the predrilled holes in the tab as a guide, transfer drill through the tab and into the rib.
6. Rivet the end ribs in place.
7. Prep, prime and paint each trim tab half and both horns as desired.

(AFTER PAINT OF TAB)

8. Drill the two holes in center rib doubler, and center rib to # 30. Rivet doubler to center rib. Refer to **FIGURE 01D-08** and the parts manual for orientation of parts.
9. Install (cleco) the center rib and doubler into the left trim tab half, lining up predrilled holes in the center rib bottom and bottom side of trim tab half. Double check center rib location, drill out 3 holes to # 30 and rivet the two aft holes only at this time.
10. Using the top holes in the tab as a guide, transfer drill through the tab and into the rib. Rivet only the top aft hole at this time.
11. Slide the right hand trim tab half into place. Make sure the two halves line up evenly, are flush and the tab is straight. Transfer drill through the six holes in the tab into the rib and rivet.
12. Drill the two pre-drilled holes in the hinge lock to 1/4". This allows the hinge lock to install over the rivets and to rest flat against the center rib wall.

INSTALLATION

13. Attach the trim tab to the right hand elevator as per parts drawing. Safety wire the attach bolts to the End Ribs. HINT: There are small openings in each End Rib, at the bend, which works well.
14. Install the hinge lock into the trim tab and slide over the center pivot stub. Hold the hinge lock tight into position and transfer drill # 30 through the top two holes in the trim tab into the hinge lock.
15. Rivet the hinge lock in place.
16. Install the bottom rivets previously omitted.
17. Run the servo to the half travel position. You can do this by applying current to the appropriate wires and moving the servo to its limiting positions. Make a pencil mark on the servo arm for each limit. Mark half travel and move the servo to this position.
18. Attach the 2 trim tab horns to the underside of the trim tab as per **FIGURE 01D-18** and the parts manual. Use the horns to transfer drill in the tab and rivet.
19. Secure the trim tab in neutral position and fabricate the push rod from the supplied all thread rod. **NOTE:** *The servo must be in its half travel position and the tab neutral.*

For further assembly and installation of elevator, refer to **HORIZONTAL STABILIZER AND ELEVATOR ASSEMBLY AND INSTALLATION (FINAL ASSEMBLY OF ELEVATOR)**.

S-7S FLOORBOARD INSTALLATION

FIT UP

(AFTER PRIMING OF FUSELAGE FRAME/ BEFORE COVERING)

1. Insert the forward floorboard with the two openings centered on the upright tangs of the fuselage. The floorboard typically touches the backside of the two tangs on the station 1 bottom crossing tube. Center from side to side and clamp the forward floorboard in position.
2. Using the fuselage frame attach tangs as a guide transfer drill #11 through the tangs and the floorboard. **NOTE:** *To prevent splintering of the top surface, press a small wood block tightly against the floorboard over the hole location while drilling.*
3. 12 holes will be located in the floorboard (8 for rudder pedal attach and 4 for the floor board). Remove the floorboard.
4. Center each wear plate with its notch over the square hole in the floorboard. Check alignment and transfer drill #11, the wear plates, using the floorboard as a guide at the 4 rudder pedal attach locations. Do **NOT** drill the 6 small wear plate attach holes in the floorboards at this time. This will be done after the floorboards receive their finish.
5. Install 3/16" nut plates to the bottom side of the 12 tangs holding the forward floorboard and the forward rudder pedals.
6. Insert the rear floorboards in the fuselage. Refer to the parts manual for orientation. Center, clamp in position and transfer drill #11 using the method described for the forward floorboard.
7. Remove floorboards and nut plate all tangs.
8. Temporarily bolt the aft floorboards and the rear rudder pedals in place and transfer drill #11 through the aft holes of the rudder pedal pivot blocks as shown in **FIGURE 01E-08**. Be sure the Rudder Pedals can move easily when bolted in place.
9. Remove floorboards for covering and painting. Sanding, staining and varnishing the floorboards prior to installation is recommended.
10. After finishing, attach the two wear plates to the floorboards. Each wear plate should have 4 previously drilled #11 holes in the front (forward rudder pedal attach). Align these holes with the corresponding holes in the floorboards, clamp or temporarily bolt in place.
11. Transfer drill # 40 through the 6 wear plate attach holes. Attach to floorboard with # 4 small pan head screws.

FINAL INSTALLATION

For final installation refer to **RUDDER PEDAL INSTALLATION**.

S-7S RUDDER PEDAL INSTALLATION

(AFTER COVERING AND PAINTING OF FUSELAGE)

1. Rudder pedals and floorboards are installed together after the fuselage is covered and painted. It is also recommended to fit and drill the fiberglass boot cowl before the forward floorboard and pedals are installed.
2. The rudder pedals, rudder pedal push pull tubes and brake push pull tubes must be prepped, primed and painted before installation. The floorboards should also have received their finish and the wear plates should be installed.
3. Bolt the aft rudder pedals to the aft floorboards through the aft holes only. Install the aft floorboard / rudder pedal assemblies with the appropriate hardware. Refer back to **FIGURE 01E-08**.
4. Bolt the forward floorboards and rudder pedals in place with the hardware shown in the parts manual.
5. Check that all pedals swivel freely. The pedals should move easy without excessive friction.
6. Install the rudder pedal push-pull tubes as per parts drawing. **NOTE:** *The push-pull tubes attach to the interior side of the aft rudder pedals and the exterior side of the forward pedals.* Do **NOT** forget the washers between pedals and push-pull tubes. The nuts should only be tightened to take out excessive play. Lubricate joints and check for friction.
7. Install the brake push-pull tubes as per parts drawing. **NOTE:** *The brake push-pull tubes are installed to the inside of the rudder pedal brake tangs (front and rear).* Do **NOT** forget the washer between push-pull tube and brake tang. Tighten nuts, lubricate and check for friction.
8. Modify foot bars per **FIGURE 01F-08**.
9. Install the foot bars to the forward rudder pedals as per parts manual. Use Loctite to secure screws. The foot bars will help to keep your feet off the brake pedals.

S-7S RUDDER SYSTEM ASSEMBLY AND INSTALLATION

RUDDER FIT UP

(BEFORE PRIMING OF FUSELAGE AND RUDDER FRAME)

1. The rudder hinges must be secured in position. Temporarily bolt the rudder to the fuselage.
2. Adjust the rudder vertically to create a gap between the top of the vertical fin and the overhang of the rudder of approximate 3/16". Also, check that the rudder horns (rudder cable attachments) are approximate in-line with the two threaded bushings for the rudder stop bolts (bottom aft of fuselage) when the rudder is deflected. Refer to **FIGURE 01G-02**.
3. Slide the hinge retaining collars against the hinges. The collars should be positioned to allow free hinge movement with minimal play.
4. Locate and drill a #30 hole on the interior aft side of each retaining collar through the leading edge spar of the rudder. Rivet collars in position as per parts manual.
5. Remove rudder from fuselage.
6. The rudder frame is now ready for prep and priming. The rudder frame is ready for covering after priming. There is no further assembly required.

PRE COVERING ASSEMBLY

(AFTER PRIMING OF FUSELAGE FRAME/ BEFORE COVERING)

7. Rudder cables, the pulleys at station 7 and the cable guides at station 5 should be installed before the fuselage is covered. This will simplify final assembly. Refer to parts manual and **FIGURE 01G-07**.
8. Route the rudder cables between the tangs at station 7 and bolt the pulleys in place. **NOTE:** *The cables route on top of the pulleys.* Check that the pulleys turn freely.
9. Bolt the cable guides to the tangs located on the station 5 bottom cross tube.
10. Roll up forward end of rudder cables, bag and tape to a fuselage interior frame member. This will keep the cables off the fabric when covering and painting.

FINAL INSTALLATION

(AFTER COVERING AND PAINT OF FUSELAGE)

11. Attach the rudder with the hardware shown in the parts manual. Lubricate hinges and swivel rudder about 30 degree left and right. The rudder should swivel freely without any excessive friction.
12. Also, check for sufficient clearance (gap) between rudder and fuselage. Excessive paint can make things not only heavy, but also tight.
13. Route the rudder cables through the cable exit fairings at aft of fuselage.
14. Attach the rudder cables to the rudder as shown in the parts drawing and in **FIGURE 01G-14**. Spring tension should be tight with the springs compressed about half of the full amount. Adjust spring tension by removing chain links. Loose steer springs will cause indefinite steering. Bend the upper inner hook of the steer springs to match the angle of the steer chain linkage, and attach the steer springs and chain to the rudder.
15. Drill the two welded tabs on bottom crossing tube of station 3 to # 11. Refer to **FIGURE 01G-15** for location. Bolt the rudder cable guides to the welded tabs.
16. Pull the rudder cables forward through the cable guides at station 3 and tangs located on top of the fuselage bottom cross tube at station 2A. The rudder cables route under the pulleys at this location. Bolt the small pulleys in place and check for free movement.
17. Bolt the rudder cables to aft rudder pedals as shown in the parts drawing and **FIGURE 01G-17**. **NOTE:** *The final tension adjustment on the multi-hole tang (forward end of cable) will be made during rigging.* Attach the rudder return springs to the forward seat frame and the rear rudder pedals as shown in **FIGURE 01G-17**.
18. Check that the rudder cables run through all pulleys and guides and have free movement.
19. For final adjustment and checks of the rudder system, refer to **RIGGING**.

S-7S FIREWALL ASSEMBLY AND INSTALLATION

ASSEMBLY

(BEFORE COVERING AND PAINT OF FUSELAGE)

NOTE: Parts call out for items other than those shown on the **Firewall Installation** parts page are referenced in **Section 003 - Engine**.

1. The metal firewall is supplied pre-cut. Most required openings are cut. Some minor adjustments on some of the holes might be required to achieve a perfect fit. **IMPORTANT:** *The firewall is **NOT** symmetrical. Pay attention to the orientation.*
2. Check fit of firewall to the related points of the fuselage cage at the eleven locations shown in **FIGURE 01H-02**. The firewall attaches to the fuselage frame at these points. Use an appropriate size bolt to pin the firewall in position. Adjust holes as required to achieve fit. It is possible to adjust hole size by filing or using a lubricated Unibit step drill.
3. Refer to **FIGURE 01H-03**. Fabricate the firewall closeout as shown to fit the firewall in the corresponding position. Use the provided raw stock. The hole in the closeout will later be used to route the electrical wiring to the engine compartment.
4. Rivet the closeout to the firewall and install the rubber grommet.
5. Match drill #11, the two pre-drilled holes in the Oil Tank Mount Bracket to the corresponding fuselage attach points and cleco. See **FIGURE 01H-05** for details. Transfer drill the lower mount brackets from the aft # 11, using the fuselage tabs as a guide. Remove Oil Tank Mount Bracket. Mount Bracket will later be riveted in place.
6. Fabric may be glued to the aft side of the firewall for aesthetic reasons. If you choose to install fabric, or any kind of soundproofing, now is the time to do so. Make sure that anything you install does not interfere with the mounting of the firewall or changes the position of it. Burn through all hole locations with a hot knife or soldering iron.

FORWARD SIDE FIREWALL ITEMS INSTALLATION

7. Refer to **FIGURE 01H-07** for forward side mounted items. **NOTE:** *It is possible to install many of the firewall-mounted items before the firewall is installed to the fuselage.* It is also possible to mount the firewall first. Do, as you prefer. The firewall is held in place by the Engine Mount and the Oil Tank Mount Bracket.
8. Install the starter solenoid with two AAPQ rivets in the appropriate mount holes as shown.
9. Install the regulator/ rectifier with two bolts in the appropriate mount holes as shown.
10. Install the heater flange assembly using 4 AAPQ rivets in the appropriate mount holes as shown. **IMPORTANT:** *It is recommended to seal the flange on the backside and at the rivets with high temperature silicon.* Install the cable housing swivel stop into the cable housing swivel stop bracket. Align with arm on heater valve. Rivet bracket to firewall as shown.
11. Install the 3 small rubber grommets in the appropriate mount holes as shown.
12. Install the large rubber grommet at the right lower side of the firewall as shown. This is the battery cable exit location.
13. Install the cooling fluid overflow bottle mount bracket using the shims and hardware as shown in the appropriate mount holes. Install the overflow bottle with supplied clamp to the mount bracket.
14. Install the gascolator mount bracket with 4 stainless steel rivets in the appropriate mount holes as shown.
15. Install the fitting in the bottom of the hydraulic brake fluid reservoir. Use thread sealant or Teflon tape. Bolt the reservoir to the firewall. Do **NOT** final tighten the bolts until the Brake Reservoir Line is installed.
16. Install bulkhead unions in lower left corner of firewall.
17. Refer to **FIGURE 01H-17** and fabricate the oil tank vent tube and the fuel overflow tubes as shown from raw stock provided and deburr.
18. Install the two fuel overflow tubes using the clamps and the spacers in the appropriate mount holes as shown. Tighten the clamps so that it is still possible to move the tubes up and down.

19. Install the oil tank vent tube using the clamps and spacers in the appropriate mount holes as shown. **NOTE:** *The small hole in the overflow tube is there to provide a source of venting in case the main opening is plugged.* Tighten the clamps so that it is still possible to move the tube up and down. **NOTE:** *The vent and overflow tubes must be temporarily moved up, when the boot cowl is installed.* After that, move them down and tighten clamps. Also, note all cut off angles of the tubes should face aft.
20. Install the four adjuster cable ferrules with supplied stop nuts in the appropriate mounting holes as shown. **IMPORTANT** *Place each ferrule at the approximate middle of its adjustment range.*

AFT SIDE FIREWALL ITEMS INSTALLATION

21. Refer to **FIGURE 01H-21** for aft side mounted items.
22. Install the four 90-degree fittings in the parking brake valve using thread sealant or Teflon tape. **IMPORTANT:** *Drill the hole in valve arm to 1/4".* Install the cable swivel stop into the valve arm. Bolt the valve to the aft side (cabin side) of the firewall in the appropriate position.
23. Install the cable housing swivel stop into the cable housing swivel stop bracket. Align with swivel in parking brake valve. Rivet bracket to firewall as shown.
24. Install the 90-degree fitting and the "T" fitting in the firewall as shown. Use thread sealant or Teflon tape.
25. Install the 3 bus bars to the aft side (cabin side) of the firewall as shown.
26. The firewall should now be installed to the airframe, if not already done.

INSTALLATION

(AFTER COVERING AND PAINT OF FUSELAGE)

27. At this time the firewall will be secured to the fuselage only with the five engine mount attach bolts and four rivets through the oil tank mount bracket.
28. Refer to **ENGINE MOUNT ASSEMBLY AND INSTALLATION** and bolt the AFT engine mount and the firewall to the fuselage frame.
29. Rivet the oil tank mount bracket through the firewall and welded tabs on the station 1 diagonals.
30. Install the oil tank with the 6" hose clamps to the oil tank mount bracket.
NOTE: *The top of the oil tank will be under the engine mount tubes with the "IN" fitting to the right and forward.*
31. The oil tank comes standard from the engine manufacturer with a drain plug in the bottom. The standard drain plug may be replaced with a quick drain valve. This will make the oil changing procedure simpler. Lockwood Aviation P/N M12175 may be used. **CAUTION:** *Check that the drain plug is safety wired. If not do so at this time.*
32. Do NOT install the oil breather line at this time. It is better to route the oil breather line after the engine is installed.
33. Refer back to **FIGURE 01H-07** and install the Brake Reservoir Line as shown. Make sure the ends of the line are cut square. Blow the line out before mounting to remove any possible debris. Tighten the reservoir bolts after the line is installed.

S-7S HYDRAULIC BRAKE INSTALLATION

(AFTER COVERING AND PAINTING OF FUSELAGE)

1. Rudder pedals and floorboards must be installed and the airplane should be on the main gear with wheel assemblies mounted. In addition, the **FIREWALL ASSEMBLY AND INSTALLATION** should be completed. The boot cowl should be fit up but not installed.
2. Install the fittings in the brake cylinder as per parts manual. Use thread seal or Teflon tape.
3. Bolt the brake cylinder to the fuselage tangs and to the rudder pedals via the U-bracket as shown in the parts manual. Adjust the U-bracket up and down as desired and tighten locking nuts. Do **NOT** forget the cotter pins.
4. Check that the pedals and the brake pedals move freely.
5. The two brake lines connected to the wheels are secured to the left and right side of the forward floorboard with plain clamps. Refer to **FIGURE 01I-05** for details. Drill # 40 holes in the floorboard at the clamp attach points.
6. Cut brake lines to length and install to cylinders, park brake valve and "T" fitting as per **FIGURE 01I-06**.
7. Route brake lines through clamps, and exit rings in fuselage belly. Press line into groove on aft side of Main Landing Gear to retain.
8. Connect lines to the fittings on the wheel assembly.

IMPORTANT

Use only aircraft-grade brake fluid.

MIL-H-5606 Red Hydraulic Fluid

Automotive brake fluid will destroy the seals in the system.

9. Fill the system from the bottom through the bleed valves in the caliper cylinders. **HINT:** *A small hand held oil pump can with a short piece of small diameter hose attached works well.* With the oil pump full of hydraulic oil, slide the hose on the oil pump over the lower left bleed valve. Remove the reservoir cap and open the bleed valve. Fill the left side until the fluid is just into the reservoir. Close the bleeder valve and pump the brake pedal to help move air into the line. Continue to fill the left side of the system until all air is removed from the system. Close the bleed valve and remove the oil pump. Refill the oil pump, attach it to the right side bleed valve, and follow the same procedure. Continue to fill the system and alternate sides until the system is free of all air bubbles. Do **NOT** overflow the reservoir, so check it often. Repeat as needed until brakes are solid.
10. Fill the reservoir to approximately 3/4 full. Install the reservoir cap.
11. Install the reservoir cap.

(AFTER INSTRUMENT PANEL INSTALLATION)

12. Mount the park brake control cable in the instrument panel as shown in the parts manual and in **FIGURE 01I-12**. Refer to Instrument Panel Installation for recommended location.
13. Install a clamp to the radio side-plate mount in a convenient location to secure the cable.
14. Route the cable to the cable housing swivel stop. Determine the correct length of cable and housing needed and cut both to length. **NOTE:** *The cable can be completely removed from the housing for cutting.* Leave the cable a little longer as needed for final adjustment.
15. Slide the cable friction block on the cable.
16. Route the cable through the cable housing swivel stop and through the wire swivel stop in the control arm of the park brake valve.
17. Adjust the control arm and cable to allow full open valve with the control knob pushed in and closed with knob pulled out. Slide a short piece of fuel line onto the wire between swivel stops to limit travel. Refer to **RIGGING** for more details.
18. Adjust the cable friction via screw in friction block as desired.
19. Loctite the screw in the wire swivel stop.

S-7S DOORFRAME BATTERY ACCESS PANEL INSTALLATION

(AFTER PRIMING OF FUSELAGE FRAME/ BEFORE COVERING)

1. Rivet single-ear nut plates to the inside of the battery access doorframe.
2. Position, transfer drill #30 and rivet doorframe to the tabs on fuselage station 6. Refer to parts manual.
3. The door should be fitted by drilling the screw holes to #11.
4. Door will attach to nut-plated frame with screws.
5. Door should be removed for fuselage covering.
6. Paint door as desired.

S-7S FUEL SYSTEM - FUSELAGE

FUSELAGE PREPARATION

(BEFORE COVERING AND PAINTING OF FUSELAGE)

1. Locate Header Tank Mount per **FIGURE 01K-01**. Locate and drill #11 through each tab. Remove Tank Mount and rivet nut plates to bottom side of tabs. Drill #11 holes in Tank Mount to 3/8" to allow Countersunk Washers to set flush. Glue Rubber Edging to top edge of Mount flanges. After covering and painting install Tank Mount and hose clamps.

HEADER TANK ASSEMBLY

2. Locate and drill fitting holes in Header Tank per **FIGURE 01K-02**. For drilling the holes a 1/2" Unit-Bit® and 3/4" Unit-Bit® work best. Locate center of each hole with a #30 drill bit, then drill full size. Deburr all holes. Thoroughly clean tank several times by rinsing with water. After confirming that all foreign material has been removed, let dry prior to installing fittings.

| |
|---|
| <u>DOUBLE & TRIPLE CHECK HOLE LOCATIONS BEFORE DRILLING.</u> |
|---|

3. To install the fuel fittings into the tank, obtain a piece of wire. Safety wire works well. Insert wire through one of the fitting holes in the tank and up through the threaded neck. Refer to **FIGURE 01K-03**. Install an O-Ring onto the tank withdrawal fitting and slide this assembly over the wire extending from the threaded neck. Bend a loop in the end of the wire to keep the fitting and O-Ring from falling off. Pull the fitting through the hole. Slide a flat rubber washer, thick steel washer, and a retaining nut over the wire and onto the fitting. Apply Loctite to threads and thread the nut on before removing the wire. **CAUTION: Do NOT get Loctite on the rubber washer.**
4. Use an Allen wrench, inserted into the tank fitting, to hold the fitting while tightening the retaining nut. **IMPORTANT: Do not allow the fitting or thick washer to rotate while tightening or leaks may occur. HINT: Prevent the thick washer from turning by holding with needle-nose Vise-Grips.**
5. Apply thread sealant to fittings and install into the tank fittings. Again, allow no rotation of the tank fitting. Refer to the parts manual for the correct parts.

6. Perform a leak test by capping off all fittings and pressurizing the tank to 1 PSI and let sit for a period of time. **CAUTION:** *Damage may result from over-pressurization.* While the tank is pressurized, check for any leaks by spraying a soap/water mixture onto the tank and around the fittings. To cap off the fittings use a 1" segment of fuel line with a bolt inserted, and fuel line clamps or similar. An alternate test is to fill the tank with water and let it sit for approximately 48 hours.
7. If desired, locate Header Tank 1/4" forward of front of Mount to locate 2" Lexan Exit Ring for Sump Drain, when covering fuselage.

(AFTER COVERING AND PAINTING OF FUSELAGE)

8. Modify Header Tank Mount Channel per **FIGURE 01K-08**. Position Header Tank 1/4" forward of front of Mount. Use large hose clamps to secure tank to mount. **NOTE:** *Modified Mount Channel will position under hose clamps, on top of tank, and be positioned so that Channel ends are flush with sides of header tank.*
9. Install two fittings to the fuel valve using thread sealant. Refer to **FIGURE 01K-09** and the parts manual.
10. Remove the handle from the fuel valve and install the valve to the three tabs of the fuselage steel frame. **NOTE:** *Valve should be "ON" when valve handle is forward and "OFF" when valve handle is inboard.* Use the mount brackets as shown in **FIGURE 01K-09**. Re-install the handle to the fuel valve.
11. Install the bulkhead fittings in the pre-cut holes on the lower left side of the firewall. Use the hardware shown in the parts manual.
12. Fabricate and install a fuel hose assembly from the bulkhead fitting in the firewall to the fuel valve and from the fuel valve to the header tank fitting. **NOTE:** *The smaller return line routes directly from the bulkhead fitting to the header tank and will not connect through the Fuel Valve.* Secure as desired using plastic ties. **IMPORTANT:** *Be sure to include the Check Valve in the Return Line.* Add clear plastic tape or split fuel hose as anti-chafe wherever the lines contact the fuselage frame or other parts.
13. Drill a #40 hole in edge of Fuel Cap. Screw on the cap and tighten. Using the hole in the cap, safety wire the cap against rotation to the fuselage frame.

(AFTER WING MOUNTED TO FUSELAGE)

14. After wings are mounted to fuselage in final assembly, route fuel line from each wing, down behind Station 3 and to Header tank. Secure as desired using plastic ties. Add clear plastic tape or split fuel hose as anti-chafe wherever the lines contact the fuselage frame or other parts.

OPTIONAL LOW FUEL WARNING KIT

15. Become familiar with the Optional Low Fuel Warning Kit on the Header Tank **Parts Drawings** and collect the parts shown in the drawings.
16. A 5/8" hole should have been located in the side of the Header Tank. If not, refer back to **FIGURE 01K-02**. Replace Silicon Washer provided with Low Fuel Warning Switch with 5/8" Rubber Washer. Install Low Fuel Warning Switch into Header Tank. Be sure to orientate the switch to allow electrical continuity (closed circuit) when installed. Use a continuity tester (Ohmmeter) to be sure. **Refer to FIGURE 01K-16**. As the header tank fills with fuel, the switch will open, turning off the LED Indicator Light.
17. Install 5/8" Rubber Washer, 5/8" Steel Washer and plastic nut on outside of tank and tighten. Double check to be sure the switch is orientated correctly.
18. Locate LED Indicator Light in instrument panel. Connect to Low Fuel Warning Switch per **FIGURE 01K-16**. Do not forget to include a proper sized breaker or fuse.

S-7S CONTROL STICK ASSEMBLY AND INSTALLATION

INSTALLATION

(AFTER PAINTING OF FUSELAGE)

NOTE: *The Control Stick Torque Tube does not require paint or finish applied. Both Control Sticks and the Control Stick Push-Pull Tube Assembly are ready for finishing as delivered. Assembly and fit-up may be done after finish is applied.*

1. For a general overview of the Control Stick Assembly layout, refer to **FIGURE 02-01**.
2. Locate Torque Tube and drill pre-located Torque Tube Side Plate mount holes to #11. Refer to **FIGURE 02-02**. Side Plates may be clecoed to the Torque Tube as you drill to assure a perfect fit.
3. Locate Nut Plates on outside of Torque Tube and transfer drill #40. **HINT:** *Fabricate a pin to help center the Nut Plates on the #11 hole for drilling.* Refer to **FIGURE 02-02**. Make sure Nut Plate is orientated lengthwise with the Torque Tube.
4. Move Nut Plates to inside of Torque Tube and rivet in place. **HINT:** *A stick or small tube with a loop of Masking Tape on it will help hold the Nut Plate in place for clecoing and riveting.*
5. Modify the two (2) Stop Rings per **FIGURE 02-05**. Slide the Stop Rings, onto the fwd end of the Torque Tube until aft of FWD Side Plate mount holes.
6. Modify Control Stick Stop per **FIGURE 02-06**.
7. Modify the Torque Tube Horn per **FIGURE 02-07**. Slide onto the aft end of the Torque Tube with bent flanges forward.
8. Press Flange Bushings into inboard side of Side Plates.
9. Press Flange Bushings into welded bushings in Control Sticks. **NOTE:** *Drill a 1/4" hole in each control stick per **FIGURE 02-09**. These holes will be used for push to talk and trim wiring exits.*
10. Loosely bolt Side Plates to Torque Tube. Refer back to **FIGURE 02-01**.
11. Install Nut Plates to lower side of forward facing Tabs on Station 2 (upper tube of gear truss).
12. Install Nut Plates to lower side of aft facing Tabs on bottom crossing tube of Station 3.

13. Temporarily install Torque Tube to the fuselage frame by bolting between the forward Pillow Blocks to the two welded forward facing tabs at Station 2 (upper tube of gear truss). **IMPORTANT:** *Be sure to position a stop ring to either side of the Pillow Blocks.* Be sure to include the washers between Pillow Blocks.
14. Temporarily install the aft Pillow Blocks to the aft facing tabs on lower crossing tube of Station 3. Check alignment of Pillow Blocks and Torque Tube. Be sure to include the washers between Pillow Blocks.
15. Adjust Torque Tube forward and aft to dimension shown in **FIGURE 02-01**. Slide Stop Rings, with slots to bottom, against Pillow Blocks, transfer drill #30 and rivet.
16. Install Torque Tube Stop Bolts (aileron stops) and 1/4" Plain Nuts to the threaded bosses welded to the aft side of the gear truss top tube. **NOTE:** *The 1/4" Plain Nut is threaded onto the bolt after it is installed. Tighten nut to retain position of Stop Bolt after Aileron Deflection is set.*
17. Locate Control Stick Stop on lower side of Torque Tube. Refer to **FIGURE 02-17**. **IMPORTANT:** *Stop should be located centered between the Stop Bolts and directly on the bottom of the Torque Tube. Check to be sure side plates are vertical when positioning.* Be sure Stop clears fuselage tubes when Torque Tube is rotated. Stop should hit against each Stop Bolt. Transfer drill #30 and rivet.
18. Position Torque Tube Horn on aft end of Torque Tube. Refer back to **FIGURE 02-01**. **IMPORTANT:** *Horn must align with Lower Aileron Cables when installed.* Transfer drill #30 and rivet.
19. Assemble Torque Tube Push-Pull Tube by pressing End Fitting into end of Push-Pull Tube, transfer drill #30 and rivet.
20. Drill pre-located thru-hole in aft end of Push-Pull Tube to #11 and deburr.
21. Install Rod End, with jam nut, into End Fitting. **CAUTION:** *Rod End must be engaged at least 10 full turns.*
22. Slip Push-Pull Tube into Torque Tube and through Glide at aft end.
23. Assemble swivel assembly (U-Brackets, washers, bolt and nut) per parts page. **IMPORTANT:** *Assembly must be able to swivel freely on the 1/4" bolt.* Bolt to aft end of Torque Tube Push-Pull Tube. **CAUTION:** *Bolt through forward U-Bracket (attaching to Torque Tube Push-Pull Tube) must be in a vertical position when installing and after rigging.*
24. Install Control Sticks between Side Plates and tighten Side Plate mount bolts. Check for free movement of Control Sticks.
25. Bolt Control Stick Push-Pull Tube Assembly to Control Sticks. Be sure to include the Thick Washers between the Push-Pull Tube Assembly and Control Sticks.

26. Bolt forward end of Torque Tube Push-Pull Tube to lower end of fwd control stick.
27. Check the entire assembly for free movement without excessive friction. Friction in the control system will have negative influence on the flying qualities of your airplane. At this time, you only need to assure that there is no excessive friction.
28. Check for free rotational movement (low friction) and adjust tightness of Pillow Blocks as required. Shim between with an extra thin washer if needed.
29. Check to be sure all cotter pins are installed where required.
30. Install Control Stick Grip assembly and wiring. Install Mac Control Stick Grip per manufacturer's instructions. Route wires through control sticks and exit through the previously drilled 1/4" hole. Clear Silicon Seal or spiral wrap can help prevent chaffing. Make sure that the wires do not bind, chafe or interfere with the control system. Secure as required.
31. If **NOT** installing OPTIONAL Passenger Seat Electric Elevator Trim, then install Control Stick Grip and End Cap to top of Control Stick. **HINT:** *A spray of soapy water to inside of Grip will allow it to slide on easier.* If installing a push-to-talk switch into the rear control stick, drill a hole through the end cap to fit the switch.
32. Proceed with installation of Push-Pull Tube Assemblies and Aileron Cable System.

S-7S AFT CONTROL STICK SPECIAL FEATURE

A special feature of the S-7S Control Stick System allows the AFT Control Stick to be removed for Special Operations. Disconnect the Control Stick Push-Pull Tube Assembly from the FWD Control Stick. Remove mounting bolts at the base of the AFT Torque Tube Side Plates. Remove the Aft Control Stick as a unit with the Control Stick Push-Pull Tube Assembly attached.

S-7S FORWARD PUSH-PULL TUBE ASSEMBLY

1. Assemble AFT 1" Push-Pull Tube by pressing End Fitting into aft end, transfer drill #30 and rivet.
2. Drill pre-located thru-hole in forward end of AFT Push-Pull Tube to #11 and deburr.
3. Install Rod End, with jam nut, into End Fitting. **CAUTION:** *Rod End must be engaged at least 10 full turns.*
4. Make 2 Bell Crank Assemblies per **FIGURE 02A-04**.
5. Fabricate 5/8" long Spacer Bushing from provided raw stock.
6. Bolt Bell Crank Assemblies, with Spacer Bushing, between welded Bushings aft of Station 4. Be sure to include the washers on outboard side of each Bell Crank Assembly. Check for free movement.
7. Proceed with 1-1/2" AFT Push-Pull Tube and Elevator Yoke Assembly.

INSTALLATION

(AFTER PAINTING OF FUSELAGE)

8. Temporarily bolt Rod End of AFT Push-Pull Tube between lower holes in Bell Crank Assemblies. Tighten bolt after final adjustment in **RIGGING**.
9. Bolt forward end of AFT Push-Pull Tube to Swivel Assembly on AFT end of Torque Tube Push-Pull Tube. **IMPORTANT:** *The angle cut of the AFT Push-Pull Tube should be orientated **FORWARD** and **UP**.*
10. **CAUTION:** *Bolt through forward U-Bracket (attaching to Torque Tube Push-Pull Tube) must be in a vertical position when installing and after rigging.*

S-7S AFT PUSH-PULL TUBE & ELEVATOR YOKE ASSEMBLY

1. Modify AFT 1-1/2" Push -Pull Tube per **FIGURE 02B-01** and deburr.
2. Press End Fitting into forward end of Push-Pull Tube. Transfer drill #30 and rivet.
3. Install Rod End, with jam nut, into End Fitting. **CAUTION:** *Rod End must be engaged at least 10 full turns.*
4. Slip Elevator Yoke into aft end of Push-Pull Tube until 1/8" from welds. Transfer drill #30. Temporarily bolt yoke in place.

INSTALLATION

(AFTER PAINTING OF FUSELAGE)

5. Remove Elevator Yoke from aft end of Push-Pull Tube.
6. Slip Push-Pull Tube into fuselage from the front.
7. Temporarily bolt Rod End between upper holes in Bell Crank Assemblies. Tighten bolt after final adjustment in **RIGGING**.
8. Bolt Elevator Yoke to aft end of Push-Pull Tube. The aft ends of the Elevator Yokes will extend out the Elevator Yoke Exit openings on either side of the fuselage.
9. Install Rod Ends, with jam nuts, into aft end of Elevator Yoke. **CAUTION:** *Rod End must be engaged at least 10 full turns.*
10. Bolt Rod Ends to Elevator Horns after Elevators are installed.
11. Modify both Pitch Stops per **FIGURE 02B-11**.
12. Apply Black Foam Tape to face of each Pitch Stop. Temporarily clamp to top of Push-Pull Tube. Make sure a Pitch Stop is forward of the Fuselage Stop Tube at Station 6 and the other aft of the tube. Final adjustment will be done in **RIGGING**.

S-7S AILERON CABLE SYSTEM INSTALLATION FUSELAGE

(AFTER COVERING AND PAINT OF FUSELAGE)

1. For a general overview over the aileron control system, refer to **FIGURE 02C-01**.
2. Assemble the pulley shackles as shown in the parts drawing and **FIGURE 02C-02**. The shackle bolts should be tight enough to eliminate any play and yet still allow free rotational movement. **NOTE:** *The shackles will only rotate a few degrees each direction prior to catching on the bolt head.*
3. Attach the lower shackle assemblies to the bushings welded to the lower side tubes of station 3. Refer back to **FIGURE 02C-02**.
4. Temporarily bolt the lower aileron cables to the top hole in the torque tube horn. Refer to the parts drawing and to **FIGURE 02C-02**.
5. Route the lower cables to each side of the fuselage and install the lower pulleys into each shackle assembly. Attach the turnbuckles to the lower aileron cables.
6. Trim the cable keepers as shown in **FIGURE 02C-06**. Install the upper set of pulley shackles, cable keepers, and small pulleys to the pulley mounts located on the top cross tube of station 3 as shown in the parts drawing. Position the cable keepers straight down. **IMPORTANT:** *Make sure bolt is tight enough to prevent rotation of Cable Keepers.* Do **NOT** install the cotter pins in the cable keepers at this time.
7. Install Small Pulley and Cable Keepers midway up on Station 3. Orientate Cable Keepers to the outboard. **IMPORTANT:** *Make sure bolt is tight enough to prevent rotation of Cable Keepers.* Do **NOT** install the cotter pins in the cable keepers at this time.

(POST WING INSTALLATION)

8. Route both sets of aileron cables into the fuselage between the top longeron and the upper doorframe tube of the fuselage.
9. Route the aft cables under the small pulleys and to the center of the aircraft. Connect both aft cables with the turnbuckle as per parts manual.
10. Route the forward cables through the large pulleys and tangs and install into the shackles. Refer to the parts drawing. Route the forward cables down to the Turnbuckles on ends of Lower Aileron Cables. Route cable on outboard side of small pulley midway up on Station 3.

11. Install cotter pins into all cable keepers as shown in **FIGURE 02C-11**. **CAUTION:** *The cotter pins must not rub on the cables and should not be used to retain the keepers in position. The keepers are retained in position by the tightening of the bolt.*
12. Proper cable tension, turnbuckle adjustment will be determined during rigging. Refer to **RIGGING** for details. **IMPORTANT:** *Safety-wire all turnbuckles after rigging the ailerons.*
13. Check all parts for free movement, interference with other parts and friction.

S-7S FLAP LEVER ASSEMBLY AND INSTALLATION

ASSEMBLY

1. Refer to the parts catalog and select the required components for assembly.
2. Press the plastic End Caps into each end of the Flap Trip Release Tube. Transfer drill 1/4" though the hole at the base of the Release Tube to remove material of End Cap for bolt insertion.
3. Bolt the Flap Handle between the two Side Plates with the welded tab facing downward. Tighten the flap handle lever pivot bolt so it is snug, but still allows the Handle to pivot freely. Do **NOT** forget the washers at the base of the Flap Handle.
4. Slip the spring into the tube of the Flap Handle. Install the Flap Trip Release Tube with End Caps installed.
5. Depress and rotate the Flap Trip Release Tube until the 1/4" hole is lined up with the slot in the Handle. Install spacer bushing until centered in tube. Install Roller/Spacer Bushings and bolt. **NOTE:** *The slot should be within the notched area of the Side Plates.* Do **NOT** tighten bolt too much, as Roller Bushings need to be able to rotate. The bushings act as rollers as they ride against the notches of the Side Plates. Tighten the bolt to the point the bushings still roll. Apply light grease to the rollers for the best action.
6. Insert 1" long bushings between forward end of Side Plates and bolt into place. **NOTE:** *Do NOT tighten bolt through Upper forward hole in Side Plates, as it will be used to mount Flap Lever Assembly to fuselage after Covering and Painting.*
7. Modify 2 Plastic Shims per **FIGURE 02D-07**.
8. Temporarily install bolts to retain Plastic Shims, 1/4" spacer bushings, and Teleflex Retainer Brackets to aft end of Flap Lever Assembly.
9. Temporarily bolt rod ends to each side of the welded tab on the Flap Handle. The exact adjustment of the rod end on the Teleflex will be determined when adjusting the flaps.
10. Bolt U-bracket to the side plate flap handle assembly. Do not forget the spacer bushing.
11. Temporarily fit-up assembly to welded fuselage tangs at seat crossing tube. The U-bracket will come to rest on top of the 1/2" square tube (fuselage frame).
12. Mark hole in square tube using the U-bracket as a guide.
13. Drill square tube # 11 through. Check for proper fit with a 3/16" bolt.

(AFTER COVERING AND PAINT OF FUSELAGE)

14. Install the flap lever assembly into the cockpit by slipping the upper forward part of the assembly between the welded fuselage tangs at seat crossing tube and bolt in place. Refer to the parts drawing. Bolt the U-Bracket to the 1/2" square tube. **NOTE:** Check for clearance of flap handle to seat crossing tube with the handle in the up most position. If needed place washers between the U-bracket, and the 1/2" square tube to obtain 1/8" minimum flap handle clearance.

(AFTER WINGS MOUNTED TO FUSELAGE)

Refer to section 05H - S-7S WING INSTALLATION

15. Route Teleflex Cables from aft edge of wings and route down aft side of Station 3. Retain with Cushioned Clamp half-way down Station 3 (refer to AILERON CABLE SYSTEM INSTALLATION - FUSELAGE). Route toward center of fuselage under Baggage Compartment area and forward on either side of Torque Tube aft Pillow Blocks. **NOTE:** Teleflex Cables should be routed outboard of Rudder Cable Guides on Station 3.
16. Route under diagonal belly tube forward of Station 3, then forward and upward to aft end of Flap Lever Assembly.
17. Disconnect Rod Ends from Flap Lever Assembly and screw onto ends of Teleflex Cables. **IMPORTANT:** Make sure Rod End is engaged at least 10 full threads.
18. Unbolt aft end of Flap Lever Assembly. Use Plastic Shims, Teleflex Retainer and 5/8" long spacer bushings, bolt end of Teleflex to the inside of the Side Plates as per the parts drawing. **NOTE:** Teleflex will attach between Retainer and plastic shim. **IMPORTANT:** Teleflex Cables should **NOT** interfere with aileron cables, rudder cables or elevator push-pull tubes. Secure with Nylon Ties as required.
19. Bolt rod ends to each side of the welded tab on the Flap Handle. The exact adjustment of the rod end on the Teleflex will be determined when adjusting the flaps.
20. Test operate the lever by pulling up on the lever, then depressing the release tube to return. Operation should be smooth.

S-7S THROTTLE LEVER INSTALLATION

(AFTER COVERING AND PAINT OF FUSELAGE)

1. Assemble the forward throttle lever to the throttle cable guide as shown in the parts drawing. Refer to **FIGURE 02E-01**.
2. Assemble the throttle lever knobs to each lever. Refer to the parts drawing and **FIGURE 02E-01**.
3. Press Flange Bushings into Throttle Levers and cable guide.
4. Locate the throttle lever mount lugs on the left side of the fuselage. Clean off any paint that may have accumulated and apply a light film of grease on the lugs.
5. Temporarily slide the lever assemblies onto their respective mount lugs. Check for free movement. Lightly sand the mount lugs if required. Remove lever assemblies from lugs.
6. Install the first set of washers as shown in the parts drawing. Refer back to **FIGURE 02E-01**.
7. Slide the throttle lever assemblies onto their respective lugs. The lever assemblies should rotate freely without excessive play. Note the proper orientation of each lever.
8. Slide the second set of washers onto the lugs.
9. Install and tighten the retaining nuts and check for play within each set of levers. The levers should feel solid and snug and rotate with just slight resistance. If any play or looseness exists, additional plastic washers may be added to achieve the correct adjustment.
10. Install the throttle linkage tube as shown in the parts drawing. **IMPORTANT:** *Note the orientation of the linkage tube in respect to the lever assemblies, as well as the orientation of each bolt.* Operate both throttle levers and check for smoothness.
11. Install the spacer, washers and friction knob through the slots in the forward throttle lever as shown in the parts drawing and **FIGURE 02E-11**. It may be necessary to trim some of the length off the friction knob threads. Add or delete 3/16" washers as necessary for proper adjustment.
12. Slide the throttle cable housing retention block on the cable-housing stub located just down and forward of the forward throttle lever.
13. Center retention block on the pre-drilled holes in the stub. Transfer drill through the stub and through the retention block centerline. See **FIGURE 02E-13**.

14. Remove the retention block and mark the two holes on the topside of the block as per **FIGURE 02E-13**.
15. Drill completely through the throttle retention block from top to bottom with a #40 drill bit. Drill only the top half of the retention block to #30. The machine screw will self-tap into the bottom.
16. The forward downward facing holes in the cable-housing stub are drilled #11 to accept the cable housing. **IMPORTANT:** *The holes in the upper aft side of the stub must remain #40.* Slide the retention block onto the stub so that the open end of the block is pointing forward.

For installation of throttle cables refer to the engine section.

S-7S ENGINE MOUNT AND ENGINE INSTALLATION

1. The AFT engine mount is supplied bare and needs surface coating as protection. Prep frame and apply surface coating as desired.
2. Before the Engine Suspension Frame Assembly is installed, the following steps should be completed:
 - Rotate water pump inlet, on lower aft end of engine, to lower right hand position.
 - Remove carburetors and re-install with drip trays as shown in the parts manual. Use the original hardware for re-installation and torque bolts to 125 in. lbs.
3. Bolt the Engine Suspension Frame Assembly to the engine. If necessary for perfect fit, place washers between mount and engine as required. **NOTE:** *Cooling hoses will need to be re-routed through the engine mount.* Torque all bolts to 310 IN. LBS.
4. Bolt the AFT engine mount to the Engine Suspension Frame Assembly with engine installed. Check for proper installation of the bolts, shock mounts, cup washers, engine mount spacers and steel bushings. Refer to the parts drawing. Install the tensile nuts and tighten until the cup washers are bottomed against the bushings. **IMPORTANT:** *Check bolts for tightness after the first several hours of operation.*

SPECIAL NOTE: *3/8" diameter bolts are used thru the rubber isolators of the Engine Suspension Frame Assembly. The Engine Suspension Frame Assembly bushings are made to fit 10mm bolts. If desired fabricate a thin bushing sleeve to take up this difference, or simply bolt up and fly. RANS has found the latter to be perfectly airworthy and is a common practice in the U.S. where the ROTAX Engine Suspension Frame Assembly is used.*
5. Bolt the engine mounts and engine assembly to the fuselage as shown in the parts drawing. Be sure the firewall is in place. It is best to lift the engine via some device (i.e. – engine hoist) to do so. A suggested lift bracket is shown in **FIGURE 03-06**. Be sure the lift bolts are long enough to thread deep into the engine without bottoming. Assemble the attachment hardware as shown in the parts manual.
6. It is important that the engine mount bolts are tight. Check that the bolts are tight and not just bottomed out. Sometimes it is necessary to add washers to correct for tolerances. **NOTE:** *The lower right engine mount main bolt is the suggested location for the main ground wire attach.* **IMPORTANT:** *Check bolts for tightness after the first several hours of operation.*

7. Install the drain lines from the carburetor drip trays to the drain tubes located on the firewall. Refer back to **FIGURE 01H-07** and the parts manual. **NOTE:** The fuel overflow lines should route continuously down to the overflow tube.

S-7S FUEL LINE INSTALLATION - FIREWALL FORWARD

NOTE: When installing fittings use thread tight or similar as a thread sealant.

NOTE: The Gascolator is Optional. If no Gascolator is installed, then it is recommended to install a fuel filter as recommended by ROTAX.

INSTALLATION WITHOUT OPTIONAL GASCOLATOR

NOTE: Contact ROTAX for recommended Fuel Filter.

1. Connect Fuel Filter with listed hardware and supplied 1/4" Fuel Line to Fuel Line from engine fuel pump.
2. Install fittings into fuel line. Attach to Firewall Fitting.
3. Route line to Fuel Filter Assembly and cut to length. Install Straight Fitting.
4. Install Hose Clamps. Tighten all connections.

INSTALLATION WITH OPTIONAL GASCOLATOR

5. The Gascolator Mount should have been riveted to the firewall during **ENGINE ACCESSORY INSTALLATION**.
6. Install fittings in Optional Gascolator. Orientate fittings per parts page drawing. Remove wire bail from Gascolator and remove bowl. Slip bail into fore and aft holes in Mount. Install top portion over mount and retain with wire bail. Re-install bowl. **IMPORTANT:** Gascolator has an **INLET** and **OUTLET** side. Orientate **INLET** side outboard.
7. Connect Fuel Line Assembly from firewall fitting to **INLET** fitting of Gascolator. Ends of Fuel Line Assembly may be turned as required.
8. Connect fuel line from engine fuel pump to **OUTLET** side of Gascolator. Tighten all connections.

RETURN LINE INSTALLATION

9. Route line from Restricted Banjo Fitting, atop the Clamp Block attached to Compensating Tube of the engine, to firewall fitting. Cut to length and attach 90-degree fitting. Install Hose Clamps. Tighten all connections.

S-7S THROTTLE CABLE AND CHOKE INSTALLATION

The throttle lever installation in the cabin should be completed. Refer to **THROTTLE LEVER INSTALLATION**.

THROTTLE CABLE INSTALLATION

1. Install the adjuster ferrule into the throttle cable mounts as per parts manual. Position the ferrule at the mid of its adjustment range to allow for later adjustments in both directions.
2. Install the throttle cable mounts to the carburetors as shown in the parts manual if not already done.
3. Determine the cable housing routing and cut to length. **NOTE:** *Cable housing routing is left to the discretion of the builder.*
4. Slide the throttle cable housing into the slot in the retention block from the forward side. Reference **FIGURE 02E-01**. The housing should enter the forward side of the stub and bottom against the interior side of the aft wall. Route the housing along the left side of the fuselage towards the top of the firewall, exiting the firewall through the rubber grommets just above the station 1 top cross tube. Zip tie the cable housing to the diagonal between station 1 and station 2. Refer to **FIGURE 09D-06**.
5. Tighten the screws in the retention block to retain the housings into the stub. **CAUTION:** *Over tightening the screw could result in a crushed housing or stripping the threads in the retention block.*
6. Route the housing to the carburetors.
7. The throttle cable has a swagged stop on each end, cut the larger of the two ends off. Feed the throttle cable through the housing from the carburetor side. The cable will exit the aft side of the stub through the retention block. Route the cable through the grooves in the cable guide of the forward throttle lever and install the cable stops and set screws. See **FIGURE 02E-11**. Pull the excess cable through until the swagged stop bottoms against the throttle lever on the carburetor. Cut off excess cable length at the throttle lever end, leaving enough for adjustment.
8. For final adjustment refer to **RIGGING**.
9. Safety-wire the cable housing ends to the adjuster ferrules. Loop the safety-wire around the cable housing several times, twist and secure to each adjustor ferrule. Refer to **FIGURE 03-13**.
10. Loctite the cable stop set screws when final adjustment has been made.

CHOKE INSTALLATION

11. Determine the cable housing routing and cut to length. Note: Cable housing routing is left to the discretion of the builder.
12. Route the choke cable housing.
13. Operate the choke lever to verify free movement. It is important that the choke operates smoothly and completely returns to its run position. If any drag is noticed or if the choke lever does not return completely, remove the choke lever and arm and apply a light film of grease to the arm. Consult the Rotax parts manual for a break down of the choke system.
14. Cut the "T" shaped swagged end off of each choke cable. **CAUTION:** *The barrel end must remain in place for attachment to the choke lever on the carburetor. See FIGURE 03-09.*
15. Install the barreled end of the choke cables into the choke lever on the carburetor. It may be necessary to lightly file the barrel in order to insert it into the choke lever. The barrel should rotate within the lever. See **FIGURE 03-09.**
16. With the barrel installed in the choke lever, feed the cable through the choke cable guide and cable housing. Pull all slack out of the cable where it exits the aft side of the firewall.
17. Install the push pull choke cable into the instrument panel. For installation of control knob in instrument panel refer to **FIGURE 01I-12** and **09D-06.**
18. The choke mixer plate should be located approximately 1 1/2" aft of the firewall. Cut the choke cables from the carburetors to length and attach them to the mixer plate using the wire swivel stops. Leave plenty of cable length for adjustment.
19. Remove the inner cable from the push pull choke cable housing and cut the housing to length. The housing should be cut short enough to allow full travel of the mixer plate.
20. Install the push pull cable and cut to length. Leave plenty of length for adjustment.
21. Attach the push pull cable to the mixer plate. Don't forget to install the friction block. **NOTE:** *It is recommended to bend the steel wire ends (control cable) 90 degree past the cable swivel stop to avoid slipping out.*
22. With the push pull knob completely in, adjust all slack out of the cables at the choke mixer plate.
23. For final adjustment refer to **RIGGING.**
24. Loctite the set screws in the wire swivel stops.
25. Safety-wire the cable housings into the adjustable ferrules. Secure all throttle and choke cable housings where necessary.

S-7S LUBRICATION SYSTEM ASSEMBLY AND INSTALLATION

AFTER ENGINE IS INSTALLED

The engine needs to be installed to the airframe.

CAUTION: *When working with the oil cooler, take care not to induce stress or over tighten fittings or bolts. Damage to the cooler may result.*

1. With a band saw or hacksaw, remove the mount tabs from the oil cooler leaving a 1/16" lip. See **FIGURE 03-10**.
2. Cut the provided silicone sheets as per **FIGURE 03-10A** and install to the upper and lower oil cooler mounts as shown in the parts drawing. **NOTE:** *The piece for the top of the oil cooler needs two holes to allow for the fittings.* Use the upper oil cooler mount as a template. Mark and cut. The sheet provides vibration isolation and should extend past the forward and rear edges of the oil cooler.
3. Apply Loctite to bolts and assemble the upper and lower mounts to the cooler using the threaded bushings. **NOTE:** *To achieve the proper compression on the silicon rubber, it might be necessary to add washers between the threaded bushings and the upper and lower oil cooler mounts.*
4. Bolt the oil cooler mount to the left side of the gearbox as shown in the parts drawing. Use Loctite to secure the bolt.
5. Attach the bent oil cooler mount to the boss on the forward left hand cylinder head. Refer to the parts drawing.
6. Attach the oil cooler and mount assembly to the gearbox and engine. See **FIGURE 03-10**.
7. Refer to the parts manual for oil line routing. **IMPORTANT:** *The pickup fitting is the straight fitting (OUT) on the oil bottle and **MUST** route to the left hand fitting on the oil cooler. The return fitting is the angled fitting (IN) on the oil bottle and **MUST** route to the fitting on the bottom of the engine.* **CAUTION:** *Failure to route the oil lines properly will result in engine failure.*

8. Inspect Oil Cooler threaded boss for nicks or burrs in O-ring contact area that might cause O-ring failure. Inspect the Cooler port threads for any buildup of coating. If needed, gently clean threads. Apply light petroleum oil to port threads. Lubricate O-ring of 90-Degree Swivel Fitting by coating with light petroleum oil and install the O-ring onto the fitting. Install fitting into the threaded boss on Oil Cooler. Using two wrenches tighten fitting until hexagon face contacts the face of the hexagon boss on Oil Cooler. **IMPORTANT:** Always use two wrenches to tighten fitting onto cooler. Using only one wrench and cooler as leverage will cause cooler to fail. Do **NOT** Over Tighten. Tighten to just snug. The O-ring is the sealing component. This is not a pipe thread.
9. Fill the oil cooler with oil using a syringe or funnel before engine start-up. Install the 90-degree fittings onto the oil bottle and cooler. Use a back up wrench on the cooler and bottle when tightening the fittings.
10. Refer to the parts manual for oil line routing.
11. Apply anti-chafe and secure all lines as necessary.
12. Cut to length and install the overflow line from the oil bottle filler neck to the 3/8" diameter aluminum overflow tube located on the right side of the firewall. For tube identification refer to **FIGURE 01H-07**. Secure ends with safety wire.

ENGINE PRE-START UP

Refer to www.rotax-owner.com for a video and ROTAX method to prime the oil system.

13. Prior to starting the engine for the first time, install a new oil filter and fill the oil bottle to the full line on the dipstick. Refer to the Rotax manuals for oil specifications.
14. Remove the top spark plugs on all four cylinders.
15. Verify the ignition switch is **OFF**.
16. Turn the prop through several revolutions by hand.
17. With the spark plugs out and from the pilot's seat, turn the key switch to the start position and crank the engine for several seconds. Check for an oil pressure indication on the gauge. If after several seconds there is no sign of oil pressure, stop cranking the engine. Remove the oil pick up line at the oil bottle. Using a funnel, prime the oil line and oil cooler to the pump. Attach the pick up line to the oil bottle and crank the engine. When an oil pressure indication is achieved, stop cranking.

18. Install the spark plugs and start the engine. Watch the oil pressure gauge as the engine starts. At the moment the engine starts, allow 10 seconds for oil pressure to come up. If there is no pressure indication within 10 seconds, shut the engine off and repeat the previous procedures. The engine will change sound (quieter) as the oil starts pumping.
19. After running the engine for a few minutes, check the oil level and check for any leaks in the system.

S-7S COOLING SYSTEM INSTALLATION

1. Bolt the radiator mount bracket to the front of the radiator as shown in the parts manual.
2. Modify the two multi-hole tangs as per **FIGURE 03-12**.
3. Bolt the modified tangs to the rear of the radiator as shown in the parts manual.
4. Bolt the radiator support tube to the tab welded to the engine mount as shown in the parts
5. Fabricate the two spacer bushings as called out in the parts manual.
6. Bolt the rear of the radiator through the two lower holes in the firewall to the two tabs of the fuselage frame at station 1. Use fabricated spacer bushings to space radiator off the firewall.
7. Bolt radiator support tube to radiator mount bracket on the front of the radiator.
8. Fabricate a line reaching from the coolant expansion bottle on top of the engine to the approximate position of the coolant recovery bottle (will be located on the left top side of the firewall). Safety-wire the line to expansion bottle and recovery bottle.
9. Install recovery bottle to the mount bracket on the firewall using a hose clamp as shown in the parts manual.
10. Fabricate hoses from the radiator to the water pump and the expansion bottle as shown in the parts manual. Both hoses will need a spring inserted in the inside to avoid collapsing of the hose in tight bends. Both hoses will also need protection against chafing on the engine mount tubes. Cut two pieces 5" long from the provided radiator hose and slot as shown in the parts manual. Wrap around the installed radiator hose and secure with two plastic ties each.

S-7S MUFFLER / HEATER WRAP ASSEMBLY AND INSTALLATION

1. Rivet heater flanges to the AFT heater wrap. **NOTE:** *Apply high temp silicone to the flange before riveting as a sealant.*
2. Install the FWD and AFT heater wrap to the exhaust muffler using the hard ware shown in the parts manual. **NOTE:** *The heater wrap should fit tight around the exhaust muffler. Shim as required using the supplied shims.*
3. Install the exhaust manifolds and the muffler heater wrap assembly to the engine as shown in the parts manual.
4. Adjust components for best fit. **NOTE:** *To install the muffler springs use the following procedure. Connect one end of the spring. Route a piece of rope through the other end of the muffler spring. Pull on the rope to extend the spring as required for connection of the other end.*
5. Safety wire the heater wrap to one of the exhaust spring mounts on one of the manifolds to avoid rotation of the heater wrap in service.

S-7S HEATER INSTALLATION

1. Install the flapper arm to the air diverter assembly. You need to transfer drill a # 40 hole for the cotter pin into the air diverter shaft. **NOTE:** *Before drilling, position the flapper arm, so that a pull on the heater control knob will open the valve to the cabin completely.* The flapper arm will need to be trimmed to clear the firewall.
2. Rivet Heater Valve to firewall.
3. Cut to fit and install duct hose from the side of heater valve to the left heater wrap flange on heater wrap.
4. Fabricate a 1.5" long bushing from provided raw stock (3/8x.095") tubing as shown in the parts manual.
5. Bolt the angle bracket to the threaded hole on the right side of the engine gearbox.
6. Cut to fit a duct hose from the right heater wrap flange to the right side of the engine gearbox. Install to the heater wrap flange and route through the engine compartment.
7. Insert inlet tube in the duct hose, and attach via clamp and fabricated bushing to angle bracket as shown in the parts manual.
8. Install control cable in instrument panel. Reference **FIGURE 09D-02** for mounting position and **FIGURE 01I-12** for installation. Do not forget the friction adjustment block.
9. Route heater control cable through rubber grommet in firewall. Reference **FIGURE 01H-07** for grommet identification.
10. Route control cable to Cable Housing Swivel on FWD side of firewall.
11. Cut cable and housing to length and attach to the air diverter flapper arm as shown in the parts manual. Pull cable out of housing enough to allowing cutting housing without cutting cable. **NOTE:** *Cut cable long enough to allow for adjustment.*
12. For adjustment refer to **RIGGING**.

S-7S CARB HEAT INSTALLATION

The S-7S is equipped with carburetor heat.

For a description of the design and adjustment refer to the **RIGGING** section.

A selector valve is mounted to the rear of each carburetor. The selector valve must be assembled from several parts. **NOTE:** *There is a right hand and left hand Carb Heat Body.* Each is assembled as a mirror image of the other.

1. Clean inside and outside of valve body and remove all burs.
2. Check that both valve shaft ends rotate freely in the bushings. There should not be a lot of friction to assure proper function of the valve. You might have to polish the ends of the shaft with fine wet/dry sand paper or Scotch-brite.
3. Press in the two bushings using loctite. The suggested way of doing this is to run a 1/4" bolt all the way through the bushings and body and to tighten the bolt until the bushings are seated properly. This will assure bushing alignment. It is suggested to leave the bolt in until the loctite is dry.
4. Insert the shaft through the bushings and check again for friction. Orientate the shaft as per parts drawing.
5. Mark valve and body, to assure that each time you remove the valve you insert it in the same orientation. Insert the valve and place it on top of the cutout in the shaft. You might have to file the two notches in the valve slightly to allow for proper fit around the bushings. Remove only as much material as needed.
6. Press the valve with your fingers down on the shaft and rotate the shaft to check fit of the valve to the body in both valve positions. The valve will need to be filed to allow for proper seating in the body. Mark the valve, where material needs to be removed, remove valve, file, insert valve again and check for fit. Repeat until satisfied. To assure proper seating of valve against body, slightly bevel the contact area.
7. Clean all parts and screw valve to shaft as shown in **FIGURE 03-14**.
8. Press the roll pin in the valve shaft. When pressing, support the shaft end to avoid bending the shaft.
9. Press in flange and secure with screws, loc washers and loctite.
10. The installation is simple. Clean inside and outside of carburetor heat assemblies.
11. Install the spring and the adjuster cable ferrule to each carburetor heat assembly as shown in the parts manual.

12. Secure intake hose to carb heat body with a hose clamp. Slide assembly onto carburetor. Secure with a hose clamp. Tighten hose clamps firmly to assure secure fit. *NOTE: Check and re-tighten these clamps after the first engine run and thereafter frequently.*
13. Safety-wire the carburetor heat assembly to the carburetor and the carburetor to the manifold.
14. Install the air filter to the top of the carburetor heat assemblies.
15. Clean the two heat exchangers and bolt to the sides of the muffler. Safety-wire the drilled head bolts to each other.
16. Cut two pieces of the duct hose to fit between the heat exchanger and the carburetor heat assembly and secure with clamps as per parts manual. *NOTE: cut the duct hose slightly longer as needed to allow for movement of components.*
17. Fabricate cable assemblies as per parts manual and install. Route to allow easy movement of the cable. For installation of control knob in instrument panel refer to **FIGURES 011-12** and **09C-07**. Don't forget to install the friction block. It is recommended to bend the steel wire ends (control cable) 90 degree past the cable swivel stop to avoid slipping out.
18. Safety-wire the control cables to the cable ferrules.
19. Adjust and perform functional check as per **RIGGING**.

S-7S BATTERY BOX ASSEMBLY AND INSTALLATION

(REFER TO PARTS PAGE # 004-02 FOR PARTS SELECTION)

BATTERY BOX AND BATTERY CABLES

(AFTER PRIMING OF FUSELAGE FRAME/ BEFORE COVERING)

Refer to **FIGURES 04-01 & 04-01A**.

NOTE: *It is easiest to install the battery box and battery cables before the fuselage is covered.*

Drill out one corner hole in the battery box mount plate to #11. Temporarily bolt the mount plate to the aft side of the corresponding tab at station 5. Using the remaining tabs as a drill guide, transfer drill through the tabs into the mount plate.

NOTE: *The center two holes remain #30. See **FIGURE 04-01**.*

Rivet the support angles to the side plate. Refer to the parts drawing. Set the battery into the side plate with it resting on the support angles. Pull the sides of the side plate tight to the battery. Place the battery box mount plate in position. Transfer drill through the holes in the mount plate into the flanges of the side plate. Rivet the mount plate to the side plate through the center two corner holes only.

Slide the Battery Bar through the holes in the battery box. Modify the Battery Bar per **FIGURE 04-01A**. Remove the battery.

Rivet nut plates to the tabs as shown in the parts manual. **NOTE:** *Only 3 tabs receive a nut plate.* Bolt the battery box and ground cable to the airframe. Refer to the parts drawing. **IMPORTANT:** *The ground cable must make bare metal contact. Remove the paint from the forward side of one mount tab to ensure a proper ground.*

Route the Battery to Solenoid cable from the battery location, down the right lower side of the fuselage to Station 3. Coil the extra cable, place in a plastic bag and secure to Station 3 until after covering and painting. Refer to S-7S INSTRUMENTS AND ELECTRICAL for more info.

BATTERY

(AFTER COVERING AND PAINTING OF FUSELAGE)

Refer to **FIGURE 04-01**.

Install the battery and battery bar. Install the cotter pins in the battery bar. Refer to the instrument section for battery cable and routing.

S-7S INSTRUMENTS AND ELECTRICAL

(REFER TO PARTS PAGE # 004-04/004-08/004-10 FOR PARTS SELECTION)

Refer to **parts page 004-04**.

Due to the different instruments and flight systems that S-7S builders are choosing, RANS does not supply gauges with the kit.

Bolt the ground cable to the battery box mount tab without the nut plate. Refer to the battery box section. Attach the other end of the cable to the negative terminal on the battery. **IMPORTANT:** Do **NOT** attach the ground cable to the battery until all wiring is complete and you are ready to start the engine.

Install the positive cable (Battery to Solenoid) into the fuselage and attach to the positive battery terminal. Attach the forward end to one pole on the solenoid. **NOTE:** The cable exits on the right lower side of the firewall through a rubber grommet. Route the cable down the right side of the fuselage using zip ties to retain it to the frame. Do not install ties or route the cable where they may come in contact with the fabric.

Bolt the Solenoid to Starter cable to the second pole on the solenoid and to the pole on the starter. Bolt the Starter to Ground cable to the large boss on the back of the starter and attach the other end to the bolt retaining the engine mount to the fuselage.

Install the instruments and switches into the instrument panel. Set the instrument panel in the fuselage. Refer to the parts pages wiring schematic, Rotax manuals and **FIGURE 04A-01** and wire all instruments and switches. **NOTE:** The VDO tachometer leads are color coded. The Tach is not affected by switching these leads. However, it is important that the lead that attaches to the (-) terminal also be grounded.

Refer to **parts page 004-10** and install the static and pitot lines as shown in the schematic. Route the lines to exit the fuselage on the left hand side of the station 3 top cross tube and connect to the fittings on the wing pitot and static lines.

Refer to **parts page 004-08** and install the jack mounts to the fuselage frame tubes as shown.

S-7S ELT AND COMMUNICATION ANTENNA INSTALLATION

(REFER TO PARTS PAGE # 004-06 FOR PARTS SELECTION)

Note: The mount plates for ELT and communication antenna are supplied in the kit.

The antennas or the ELT are not included.

It is recommended to install the mount plates and to fit the ELT mount before the fuselage is covered.

ANTENNA MOUNT PLATES

(AFTER PRIMING OF FUSELAGE FRAME/ BEFORE COVERING)

Refer to the parts manual. Clamp mount plates in place and transfer drill through welded tangs in fuselage # 30. Rivet mount plates in place. **Note:** Do not rivet the most forward rivet on the ELT antenna mount plate at this time. This rivet will be installed together with the skylight.

Fit and transfer drill ELT mount tray to tangs in fuselage.

Install Tinnerman nuts to the 4 fuselage tangs at the ELT mount tray location and bolt on tray.

Check antenna fit in mount plates and modify plates as required.

ANTENNAS AND ELT

(AFTER COVERING AND PAINT OF FUSELAGE)

Burn holes through the fuselage fabric at the antenna locations and install communication and ELT antennas as per manufacturers instructions.

Install ELT as per manufacturers instructions.

S-7S WING – MAIN STRUCTURE ASSEMBLY

NOTE: 3M Brand DP-460 Epoxy Adhesive is recommended for bonding the sheet metal wraps to the FWD & AFT wing spars. *Leading Edge, Root, and Tip Wraps are riveted with 1/8" Stainless Steel Flush rivets. A suitable 1/8" Dimpling Tool and Counter Sink will be required. Aircraft Spruce has an inexpensive 1/8" Pop Grip Dimpler.*

IMPORTANT: *Wings are mirror assemblies, repeat the procedures described for one to both, unless otherwise specified.*

It is **NOT** necessary to trial fit the wings to the fuselage after building the wing frames. We recommend having all assemblies and installations related to the wing completed, before the wings are final installed to the fuselage.

WING SPAR ASSEMBLY

1. Prior to the assembly of the Spars, it is important to familiarize yourself with the orientation of the Spars. When working with long tubing such as Leading and Trailing Edge Spars, padded sawhorses provide an ideal workbench.
2. Locate the root and tip end of both the Leading and Trailing Spars, refer to **FIGURE 05-02 and 05-02A**. You must also determine the forward and aft side to each spar span wise.
3. **IMPORTANT:** *Double check that you have the spars correctly orientated to assemble a right and left hand of each spar. Mark all four spars with "left, right, forward, and aft".* **NOTE:** *The left hand Leading Edge Spar is also identified by the pitot/static mounting hole. Refer to **FIGURE 05-02** for location. Be sure to build a left and right hand set of spars. Be sure the Lift Strut Attach Plates are orientated correctly on each spar. Refer to **FIGURE 05-03**.*
4. Locate the root end of both Leading Edge Spars and the 2 slotted Leading Edge Spar Root Doublers.
5. Squeeze the slotted Root Doubler together and slide it in the root end of each Leading Edge Spars, with the slot facing down. Push the doubler in with a block of wood until flush with the Spar root end. Refer to **FIGURE 05-05**. **HINT:** *A large hose clamp may be used to squeeze the Root Doubler together to allow easier insertion.*
6. Transfer drill the root doubler # 30 using the pre-drilled holes in the spar as a guide and cleco to the spar as shown in **FIGURE 05-05**.

7. Transfer drill through Spar and Root Doubler #40 in 4 places using the Leading Edge Patch as a guide and cleco. Refer to **FIGURE 05-05**.
8. Remove one cleco at a time and drill out to #30 (4 places) and cleco.
9. Drill out the one hole to #11 as per **FIGURE 05-05**.
10. Remove Leading Edge Patch and deburr.
11. Rivet the Leading Edge Patch to Spar and Root Doubler as per **FIGURE 05-05**. **IMPORTANT:** *One hole does not receive a rivet.*
12. Working with only the Leading Edge Spars, find the pilot holes located approximately 47" & 50" outboard from the **ROOT** end of the spar. These holes are drilled in the AFT side of the spar only. Chase drill one hole to #11 and cleco the Long Wing Channel in place. Align the Channel on the Spar centerline so the holes in the Channel match the pre-drilled holes in the Spar. Transfer drill through the Channel into the Spar using a #11 bit and cleco. Transfer drill through the center hole in the Channel through the Spar. Remove the Channel from the spar.
13. Drill out the center hole in the Leading Edge Spar Doubler to #11.
14. Tape the doubler onto an end of a Wing Drag Brace in such a manner that the Drag Brace can be pulled off the Doubler after it is inserted into the Spar. See **FIGURE 05-14**. Using the Drag Brace as a handle, insert the Doubler into the Spar from the root end until the center hole in the Doubler is in line with the Channels center hole in the Spar. Using the center hole, cleco the Doubler and Channel to the Spar. Refer to **FIGURE 05-14**. Pull the Drag Brace loose from the Doubler, making sure that the Doubler remains in alignment with the spar.
15. Using a #11 bit, transfer drill through the outboard holes in the Channel and Spar through the Doubler. Drill one hole at a time and cleco. Remove one cleco at a time and rivet with 3 stainless steel rivets. Refer to the parts drawing. **NOTE:** *This Doubler is only installed in the Leading Edge Spar and at this location.*
16. Drill out the holes located approximate 2.5" and 19.5" outboard from the **ROOT** end of the Leading Edge Spars to #11. Rivet a U-Bracket with a single stainless steel rivet to each of these locations.
17. Working with only the Trailing Edge Spars, find the pilot holes located approximately 48.8" & 51.8" outboard from the **ROOT** end of the spar. These holes are drilled in the front side of the spar only. Chase drill one hole to #11 and cleco the Long Wing Channel in place. Align the Channel on the Spar centerline so the holes in the Channel match the pre-drilled holes in the Spar. Transfer drill through the Channel into the Spar using a #11 bit and cleco. Transfer drill through the center hole in the Channel through the Spar. Rivet Channel to Spar using 3 stainless steel rivets.

18. When attaching the Strut Attach Plates to the Spars, it will be necessary to drill out the spars to 3/8" diameter. **IMPORTANT:** Do **NOT** drill the Strut Attach Plates to 3/8". The most accurate way to drill the 3/8 " holes is to first drill 1/4" and bolt one end of the Strut Attach Plate to the Spar with a 1/4" bolt.
19. Drill 1/4" and bolt a second hole using the Strut Attach Plate as a guide. Drill the third 1/4" hole, remove the Strut Attach Plate, and drill all three Spar holes to 3/8 ". **HINT:** A Unibit[®] step-drill produces the best results. **IMPORTANT:** Make sure the bit you use produces a tight fit between bushing and Spar. **REMINDER:** When drilling through tubing, drill from each side. Deburr and insert the Spacer Bushings.
20. When installing the anti-crush Spacer Bushings into the Spars, each Bushing should be flush with the outside surface of the Spar. See **FIGURE 05-18**. **NOTE:** It is possible the Spacer Bushings are slightly too long and may have to be filed down to the outer dimension of the Spar tubing.
21. Drill out the Long Wing Channel and the U-Bracket to allow for the 1/4" Bolts.
22. Bolt the Strut Attach Plate and Long Wing Channel (Leading Edge Spar), or the U-Bracket (Trailing Edge Spar), to their respective Spar.
23. Step drill the hole 8" inboard from the tip end on the **LEFT** Leading Edge Spar to 3/4" using a Unibit[®] step-drill on both sides of the Spar. Refer to **FIGURE 05-02**. This is the location for the Pitot/Static Probe.
24. Install the 3/16" Nut Plates to all Flap Hinge locations on the Trailing Edge Spar. Refer to **FIGURE 05-03** for locations. Place the Nut Plates on the forward side of the Spar and secure with #40 aluminum pop rivets. **HINT:** Use a 3/16" bolt to hold the nut plate in place when drilling. Position nut plates horizontally in-line with the Spar.
25. Install Trailing Edge Spar Root Fittings and Long Wing Channels as per parts manual to both Trailing Edge Spars. Remove equal material from the forward and aft side of the Root Fitting. Profile, with a fine-tooth file, to achieve a perfect fit inside the Spars.

WING FRAME ASSEMBLY

26. Select either a Right or Left hand set of Leading and Trailing Edge Spars. Place on padded sawhorses and bolt in root Inner Compression Tube. **IMPORTANT:** *Be sure to install the Aileron Cable Rub Block and the Aileron Cable Retention Plate at the Trailing Edge Spar.* Refer to **FIGURE 05-26**. Install Single-Ear Nut plates to the top of Aileron Cable Retention Plate. **IMPORTANT:** *Be sure the nut plates align with the Rub Block.* Refer to **FIGURE 05-26A**. Only finger tighten the 2 bolts at this time.
27. Slide the Compression Tube Doubler inside the Bell Crank Compression Tube so that the holes align with the AFT holes in the Compression Tube. Reference **FIGURE 05-27**. **NOTE:** *The Bell Crank Compression tube has two holes that are used for the Bell Crank Brace.* Place the Compression Tube with these holes orientated to the Trailing Edge Spar.
28. Install both the Flap and Bell Crank Compression Tubes into the wing frame. Refer to the parts drawing for orientation of each Compression Tube. **NOTE:** *Do NOT tighten the rear bolt on the Bell Crank Compression Tube at this time.*
29. Install the Jury Strut Bracket to the forward bolt retaining the Flap Compression Tube. Refer to **FIGURE 05-26**.
30. Assemble the Teleflex Retainer and the Cable Guide to the Flap Compression Tube as per **FIGURE 05-26**.
31. Using a #40 bit pre-drill the Door Upcatch Socket as shown in **FIGURE 05-31**. Slide the Door Upcatch Socket onto the Root Drag Brace prior to installing them into each wing. Install Drag Braces. Position Door Upcatch Socket per **FIGURE 05-31**, but do **NOT** drill at this time.
32. Cut four bushings, 1" long, from 3/8" x .095" material. These will later be inserted between Bell Crank Braces.
33. Slide Bell Crank Braces into position as per parts manual (between Compression Tube and U-bracket). Refer to **FIGURE 05-27**. Cleco the 2 braces together along their flanges and to the U-bracket. Temporarily bolt to Compression Tube. Transfer drill #11 through 3 forward Brace holes, top and bottom. Cleco. Transfer #30 through remaining holes in Brace along Compression Tube.
34. Remove all clecos and deburr parts. Install 1" bushings. **HINT:** *A dab of JB Weld on ends of bushing will help hold them in place.* Re-install Braces with clecos. Remove one cleco at a time and rivet. Refer to parts manual and **FIGURE 05-27** for rivet details. **NOTE:** *Three holes for mounting Bellcrank Bearing Mount Blocks on top and bottom do not receive rivets.*

35. Drill out the first hole on each leg of the Tip Bow to #30. Locate and mark the trailing edge side of the Tip Bow. **NOTE:** *The trailing edge side has an additional hole drilled (this hole is **NOT** used on the S-7S).* Refer to **FIGURE 05-35**. Insert the Tip Bow into Leading and Trailing Edge Spar and cleco Tip Bow through the FWD side of Leading Edge Spar and the AFT side of Trailing Edge Spar. Make sure the orientation of the Tip Bow is correct. Center the pre-drilled #40 hole in the Tip Bow with the pre-drilled #30 hole in the Spars and chase drill the Tip Bow to #30 and cleco. Remove one cleco at a time and drill out the four holes to #11.
36. **NOTE:** *The Tip Bow is purposely under bent.* This forces a curve into the Tip Bow when installed. Once the fabric is installed, this curve will straighten. Rivet the Tip Bow to both the Leading and Trailing Edge Spars with 3/16" stainless steel rivets.
37. Compression Tubes may be final-bolted in place. Do **NOT** final-bolt Drag Braces at this time, as they will need to be removed for installation of Wing Ribs. Instead, temporarily secure Drag Braces with bolts and nuts finger tight.

S-7S FUEL TANK ASSEMBLY AND INSTALLATION

ASSEMBLY

(BEFORE COVERING OF WINGS)

Installation of the Fuel Fittings will be easier to accomplish after the hole for the Fuel Cap is located and cut. Refer to **UPPER AND LOWER ROOT SKIN INSTALLATION** in **Section 05C**. Final installation of the Fuel Tank should be done after all fittings are installed.

1. **NOTE:** *Each fuel tank is pressure tested from the supplier and guaranteed leak proof.* RANS also performs a pressure test on each fuel tank before they are packed. After you have installed the fuel fittings, it is advisable to perform a final leak test. You may do so by capping off all fittings and pressurizing the tank to 1 PSI and let set for a period of time. **CAUTION:** *Damage may result from over-pressurization.* While the tank is pressurized, check for any leaks by spraying a soap/water mixture onto the tanks and around the fittings. To cap off the fittings use a 1" segment of fuel line with a 1/4" bolt inserted, and fuel line clamps or similar. An alternate test is to fill the tank with water and let it sit for approximately 48 hours.

DOUBLE & TRIPLE CHECK HOLE LOCATIONS BEFORE DRILLING.

2. Locate and drill three (3) 1/2" diameter holes for the fuel fittings at the locations shown in **FIGURE 05A-02**. For drilling the holes a 1/2" Uni-Bit[®] works best. Locate center of the hole with a #30 drill bit, then drill full size. Deburr all holes. Thoroughly clean each tank several times by rinsing with water. After confirming that all foreign material has been removed, let tanks dry prior to installing fittings.
3. To install the fuel fittings into the tank, obtain a piece of wire approximately 40" in length. Safety wire works well. Insert wire through one of the fitting holes in the tank and up through the filler neck. Refer to **FIGURE 05A-03**. Install an O-Ring onto one of the tank withdrawal fittings and slide this assembly over the wire extending from the filler neck. Bend a loop in the end of the wire to keep the fitting and O-Ring from falling off. Pull the fitting through the hole. Slide a flat rubber washer, 1/2" thick steel washer, and a retaining nut over the wire and onto the fitting. Apply Loctite to threads and thread the nut on before removing the wire. **CAUTION:** *Do NOT get Loctite on the rubber washer.*

4. Use a 1/4" Allen wrench inserted into the tank fitting to hold the fitting while tightening the retaining nut. **IMPORTANT:** Do not allow the fitting or 1/2" thick washer to rotate while tightening or leaks may occur. **HINT:** Prevent the 1/2" thick washer from turning by holding with needle-nose Vise-Grips.
5. Apply thread sealant to fittings and install into the tank fittings. Again, allow no rotation of the tank fitting. Refer to **FIGURE 05A-02** and the parts manual for the correct parts.
6. Perform leak test as described above.

INSTALLATION

(AFTER WING FRAME ASSEMBLY/ BEFORE COVERING OF WINGS)

7. Locate the pre-drilled hole for the U-bracket (S2-SAB) 19.5" outboard from the **ROOT** end of the Leading Edge Spar on the AFT side. Drill spar #11 and rivet U-bracket to the AFT side of the Leading Edge Spar. Drill and rivet a side-by-side nut plate to the top of the U-bracket. **HINT:** Squeeze the rivets with a Rivet Squeezer to allow the Outer Tank Support Tube to clear. A pair of Vice-Grips with tape on the jaws will work to squeeze also. Bolt the forward end of the Outer Tank Support to U-bracket. With the Fuel Tank in position, resting on both the Root Compression Tube and the Outer Tank Support, pull the Outer Tank Support into place against the tank. **NOTE:** The AFT end of the Outer Tank Support is cut diagonally to clear the drag brace. See **FIGURE 05A-07**.
8. Drill the two holes in the U-bracket (KPAC0055) to # 11. Bolt the U-Bracket to the Outer Tank Support. Fasten the U-bracket to the drag brace by drilling two #30 holes in the U-bracket on centerline. Rivet with two 1/8" stainless steel rivets. Refer to **FIGURE 05A-07**. Install a side-by-side nut plate to the topside of the U-bracket. Squeeze the rivets as previously described.
9. Position the Fuel Tank in the wing. Make sure the tank is against the Leading Edge Spar. Position the tank on the support tubes with light pressure, making sure that the tank is seated flat and contacting the support tubes throughout the length of the tank.
10. Position the Fuel Tank Retainer Angle against the aft side of the fuel tank on top of the Compression and Drag Brace Tubes. Refer to **FIGURE 05A-10**. Transfer drill through the pre-located hole in the Retainer into the top center of the Inner Compression tube. Locate a hole on top centerline of the Drag Brace for attaching the outer end of the Retainer Angle. Drill #30.
11. Rivet the Fuel Tank Retainer Angle in place with stainless steel rivets as per parts manual.

FUEL CAP ASSEMBLY

12. Collect Fuel Cap Assembly and metal Retainer.
13. Notice the Flush Fuel Cap must be orientated correctly to insert and lock into its Mounting Flange.
14. Center metal Retainer on bottom side of Mounting Flange. Refer to **FIGURE 05A-14**. Transfer Drill #11. Cleco as you drill. **NOTE:** *Mark Mounting Flange to allow re-alignment of Retainer during assembly into tank.* Modify metal Retainer per **FIGURE 05A-14**. Also, drill Mounting Flange to match. **IMPORTANT:** *When drilling be sure that the Vent hole will be orientated **OUTBOARD** and the Fuel Cap opening tab is orientated **AFT**.* Final installation will be completed later.

FUEL LINE INSTALLATION WING

(AFTER WING FRAME ASSEMBLY/ BEFORE COVERING OF WINGS)

15. Wing tanks must be final installed.
16. All fuel lines should be cleaned in and outside before installation. Blow out the inside of all lines.
17. Line from aft inboard side of tank to Sight Gauge will be located and installed after the Root Rib is fit-up to wing.
18. Fuel withdrawal line from aft center of tank may be installed after covering and painting.

(AFTER COVERING AND PAINTING OF WINGS)

19. Install Fuel Vent and Cover Ring.

S-7S AILERON BELL CRANK AND CABLE INSTALL - WING

(AFTER WING FRAME ASSEMBLY/ BEFORE COVERING OF WINGS)

1. Locate the parts for the Bell Crank Assembly as per parts manual.
2. Assemble 2 Upper and 2 Lower Bell Crank Assemblies per **FIGURE 05B-02** and **FIGURE 05B-02A**.
3. Fabricate 2 Bushings, 1.06" long from provided material. This bushing is used to keep the Bell Crank Mounts parallel to each other.
4. Bolt Bell Crank Mounts to Bell Crank Brace. Install Rib Reinforcement to bottom of Bell Crank Assembly. Refer to parts page for orientation. Refer to **FIGURE05B-04**.
5. Bolt the entire Aileron Bellcrank Assembly In place. Do **NOT** tighten the bolt through the Bell Crank Arm Assemblies at this time. **NOTE: The Lower Bell Crank Arm will need to be swung out of the way to rivet the Rib to the Rib Reinforcement during Rib Installation.** Do not forget the Spacer Bushing between the Mounts.
6. Install Male Rod End with jam nut to lower side of Bell Crank Arm Assembly.
7. Install the Aileron Cable and Aileron Link Cable to the Bell Crank Upper Arm as per parts manual. **IMPORTANT: Do NOT forget the two stainless steel bushings.** Final install cotter pins and tighten all connections after Wing Ribs are installed.
8. Check entire assembly for free movement, and friction.
9. Route cables through ribs and through the Cable Rub Block as per **FIGURE 05B-09**.
10. Cut white plastic anti-chafe (KPWI0612) to length from raw stock and press onto top of outer Drag Brace as per **FIGURE 05B-09**. The anti-chafe prevents the cables from rubbing on the frame tubing.

S-7S WING – RIB & SHEET METAL INSTALLATION

WING RIB ASSEMBLY

NOTE: LORD brand FUSOR 108B/109B Adhesive is recommended for bonding the sheet metal wraps to the FWD & AFT wing spars. *Leading Edge, Root, and Tip Wraps are riveted with 1/8" Stainless Steel Flush rivets. A suitable 1/8" Dimpling Tool and Counter Sink will be required. Aircraft Spruce has an inexpensive 1/8" Pop Grip Dimpler.*

IMPORTANT: *Wings are mirror assemblies, repeat the procedures described for one to both, unless otherwise specified.*

A corrosion protection coating is recommended between the Ribs and Rib Clips.

1. Select the necessary parts as shown in the parts drawing. Refer to **FIGURE 05C-01** for Rib location and position numbering.
2. The ribs are pre-pressed aluminum. The forming process leaves the ribs slightly bowed. **IMPORTANT:** *Lay the ribs, flange side up, on a flat table. Use "Fluting Pliers" on the depressed areas to take the curvature out of the ribs. Flip the rib over and check that flange surface touches table top evenly at all locations. Do this for all ribs.*
3. Separate into Right Hand & Left Hand ribs.
4. The open flange side of the ribs will face toward the wing root. The exception is the root rib (#1) which will face the tip.
5. Each wing will have a root and tip rib, which are different from Ribs #2 thru #11.

INSTALLATION

(AFTER ASSEMBLY OF WING FRAME)

6. Pre-drilled #30 rib mounting holes are located in Leading & Trailing Edge Spars. De-burring of holes may be required. Modify 2 FWD Rib Attach Clips per **FIGURE 05C-06**. Orientate with tabs to the outboard side and rivet to pre-drilled holes at root of Leading Edge Spar.
7. Modify Root Ribs and 2 AFT Rib Attach Clips per **FIGURE 05C-07**. Orientate with tabs to the outboard side and rivet to pre-drilled holes at root of Trailing edge Spar.
8. Cleco Attach Clips to Spars for Rib locations #4 & #11. Orientate with tabs facing inboard. Rivet Clips to Spars.
9. Modify Ribs per **FIGURES 05C-09** thru **05C-09B**. Install Tinnerman Clips to lower flange of Root Rib.
10. Rivet Rib Clips to outboard side of ribs #2, 3, 5, 6, 7, 8, 9, and 10.
11. Rivet Clips to inboard side of Tip Rib. Cleco and rivet Tip Rib to Tip Bow. Refer to **FIGURE 05C-11** for location.
12. Loosen Drag Braces in Wing. Slip Ribs #2 thru #4 over the inboard Drag Brace and Ribs #5 thru #7 over the outboard Drag Brace. Cleco in place.
13. Cleco Ribs #8 thru #11 in place.
14. Transfer drill #30 through Bellcrank Rib Reinforcement into Rib #8. Cleco as you drill. Do **NOT** rivet at this time.
15. Rib # 1 and #2 sandwich the fuel tank and should not be riveted to clips until after fuel tank installation.

RIB STRINGER INSTALLATION

16. Slide Outboard Rib Stringers into wing from the outboard side and cleco to upper and lower tabs on Ribs #3 thru #11. **IMPORTANT:** *Outboard end of Outboard Rib Stringer may be identified by hole to hole dimension of 12.75".* **NOTE:** *Flanges of stringers will face downward.*
17. Rivet Inboard Rib Stringers to upper and lower tabs of Ribs #2 and #3. **NOTE:** *Un-cleco Rib #2 from the Spars to aid in access for riveting.* Do **NOT** forget to rivet the Outboard Stringers with the Inboard Stringers at Rib #3.
18. Re-cleco Rib #2 to the Spars.
19. Modify Tip Rib Stringer per **FIGURE 05C-19**. **NOTE:** *Each Tip Rib Stringer will be modified to create an Upper and Lower Stringer.* Cleco each Tip Rib Stringer from tab on Rib #11 to respective tab on Tip Rib.
20. Rivet Upper and Lower Stringers to Ribs. **NOTE:** *Rib #8 must be moved away from the Compression Tube to allow riveting of the Lower Rib Stringer sections.* Rivet Rib #8 to Bellcrank Rib Reinforcement and re-install.
21. Rivet all ribs to Spars and/or Clips.

UPPER AND LOWER ROOT SKINS

22. The root skins consist of an Upper and Lower Skin.
23. **IMPORTANT:** *Upper Root Skin orientation is determined by an extra hole in the FWD Tip side of the skin. Refer to **FIGURE 05C-23** for orientation.*
24. The Lower Root Skin has flanges on the Leading and Trailing Edge. **NOTE:** *There is a left-hand and right-hand as well as a top and bottom side to the Lower Root Skin. The Lower Root Skin is positioned such that the flanges point up as to “envelope” the tank. #40 holes are pre-located along the root side of the skin which match to Tinnerman locations in the Root Rib. Refer to **FIGURE 05C-24** for orientation.*
25. Most rivet holes in the Upper and Lower Root Skins are dimpled to accept countersunk rivets. Some rivet locations must **NOT** be dimpled. Refer back to **FIGURES 05C-23** and **05C-24** for details. **IMPORTANT:** *Be sure the dimpling is done to the correct sides of the Root Skins.*
26. Root Skin Stiffeners will also need to be dimpled.
27. Cleco Root Skin Stiffeners to **lower** side of the Upper Root Skin. Riveted flange of Stiffeners will face AFT.
28. Cleco Root Skin Stiffeners to **upper** side of Lower Root Skin. Riveted flange of Stiffeners will face AFT.
29. Rivet Stiffeners to Root Skins.
30. Cleco Lower Root Skin to Root and #2 Ribs. Cleco Upper Root Skin to Root and #2 Ribs.
31. Refer to **FIGURE 05C-31**. Mark and drill the two #30 holes as shown through the Upper Root Skin and Trailing Edge Spar. **CAUTION:** *Do **NOT** locate or drill any other holes in the spar, structural damage to the spar could result.*
32. Using the AFT edge of the Upper Root Skin as a guide, mark a line on the Trailing Edge Spar. Bond the Root Skin to the spars during Leading Edge Wrap bonding. Refer to **LEADING EDGE WRAP** for more details.
33. Using the FWD edge of the Upper Root Skin as a guide, mark a line on the Leading Edge Spar. Bond the Upper Root Skin to the spars during Leading Edge Wrap bonding. Refer to **LEADING EDGE WRAP** for more details.
34. Now is a good time to secure the lower Sight Gauge fittings inside of the Root Rib. Position the Internal Thread Elbow (refer to Fuel Tank Assembly parts page) inside of the lower Sight Gauge hole in the Root Rib. Secure the fuel line to the compression tube with a Nylon Tie and stand-off. Cut fuel line to length as required to connect to the fitting on the AFT inboard side of the Fuel tank.

35. Rivet Lower Root Skin to Root and #2 ribs.
36. Locate the parts for the Fuel Tank Cap Assembly.
37. Modify Capture Ring per **FIGURE 05C-37**. Glue Fuel Scupper to Capture Ring. 3M Super 77 Adhesive or similar will work well. **IMPORTANT: Holes must align!**
38. Place 2" masking tape over hole in top center of Fuel Tank Filler Cap area. Refer to **FIGURE 05C-38**. Locate and mark the center of the opening. **NOTE: Center-mark may not be centered on pre-located manufacturing hole in tank.**
39. Fabricate a Drill Guide from scrap Aluminum sheet per **FIGURE 05C-38**.
40. Secure Drill Guide to top of Fuel Tank with 2 small sheet metal screws with the center hole centered on the mark.
41. Cut hole into the top of the tank with a fly-cutter or hole-saw using the Drill Guide. Refer back to **FUEL TANK ASSEMBLY** for required hole size. Clean debris from tank. Install fuel fittings if not already done.
42. Modify Cover Ring per **FIGURE 05C-42**. Orientate Scupper per **FIGURE 05C-42A**. Cleco Scupper, Capture Ring, and Cover Ring onto Upper Root Skin. **NOTE: The Scupper and Capture Ring install under the Upper Root Skin.** Refer to **FUEL CAP ASSEMBLY**.
43. Place Fuel Cap Assembly centered in the opening. Align Fuel Cap Assembly holes with Scupper holes and transfer drill #11. Cleco as you drill.
44. Modify Fuel Cap, Retainer and Scupper for Fuel Vent Tube. Be sure to orientate Fuel Vent Tube hole to outboard. Transfer drill 25/64". Clean debris from tank.
45. Glue Scupper, and Capture Ring to underside of Upper Root Skin. Cleco Cover Ring in place. Be sure Capture Ring is secure to underside of Scupper. Cover Ring will be removed for covering. Secure Fuel Cap Assembly to Fuel Tank. Be sure to use a fuel resistant sealant on the screw threads. RANS uses DOW 730 Solvent Resistant Sealant. Do **NOT** install Fuel Vent at this time; it will be installed after covering and painting.

LEADING EDGE TIP WRAP

46. The Leading Edge Tip Wrap must be pre-fit before final installing the Leading Edge Wrap. The tip wraps are pre-formed at the factory to match the radius of the Leading Edge Spar and the Tip Bow. **IMPORTANT:** *The two holes in the front should line up approximately with the forward centerline of Leading Edge Spar and Tip Bow.* If more forming is required, use your hands and push the Tip Wrap around the Leading Edge Spar and Tip Bow to achieve the desired shape.
47. Temporarily lay Leading Edge Wrap on Ribs. Cleco Leading Edge Wrap Stringer to Leading Edge Wrap. Refer to **LEADING EDGE WRAP** installation instructions. Temporarily Cleco top holes of Leading Edge Wrap to top forward hole of each Rib. This will help set proper spacing of Rib #11 for positioning of the Tip Wrap. The Tip Wrap will lay under the Leading Edge wrap when final installed.
48. Slip the Tip Wrap under the Leading Edge Wrap and position the Tip Wrap around the Leading Edge Spar and Tip Bow as shown in **FIGURE 05C-48**. **NOTE:** *The two holes in the front should line up approximately with the forward centerline of Leading Edge Spar and Tip Bow.* Drill these 2 holes #40 and Cleco to help hold the Leading Edge Tip Wrap in position. Upper outboard hole in Tip Wrap should align with centerline of Tip Rib. Transfer drill #30 and Cleco to the Tip Rib.
49. Transfer drill #30 using the Leading Edge Wrap as a guide and Cleco to the Leading Edge Wrap and Rib #11. Rivet after the Leading Edge Wrap is bonded. Refer to **FIGURE 05C-48**.
50. Pull Tip Wrap to back side of Leading Edge Spar and Tip Bow. Transfer drill #30 and Cleco. **NOTE:** *Trim Tip Wrap as needed for clearance with Rib Clips.*
51. Drill Tip Wrap #40 to match pre-drilled holes in Tip Rib. Refer back to **FIGURE 05C-48**. Use a hole finder or transfer drill from the underside.

LEADING EDGE WRAP

52. LORD brand FUSOR 108B/109B adhesive is recommended for bonding the sheet metal wraps to the FWD & AFT wing spars. Three smaller tubes should be sufficient. A plunger and 3 or 4 mixer tubes will also be required.
53. LORD 703 Prep/Cleaner should also be used. Both products are available online, if not available locally.
54. Unroll Leading Edge Wrap and lay it carefully on the Wing Ribs positioned as illustrated in **FIGURE 05C-54**. Rivet the Leading Edge Wrap Stringer to the underside of the Leading Edge Wrap. **NOTE:** *The flange will be forward on the right Wing and aft on the left Wing.* Cleco Wrap to Ribs. Stringer will set into cut-outs in the ribs. **NOTE:** *1-inch wide thin double-stick Acrylic foam tape is recommended on the Rib to Wrap contact area. Leave the protective paper on the wrap side of the tape until ready to final install the wrap.*
55. Using the Leading Edge Wrap as a guide, mark a line along the length of the Spar. Remove the Wrap.
56. Cleco the Leading Edge Wrap in place on the Wing. If satisfied, rivet the Leading Edge Wrap to each Rib. Bond the Wrap to the Spar. **IMPORTANT:** *The Wrap is retained to the Spar with **ONLY** the adhesive.* It is important that you make a good bond between the Wrap and the Spar. **CAUTION:** *Do **NOT** drill or install any rivets into the Spar.* **HINT:** *Masking tape on the Spar, just forward of the bond area, will help prevent excess glue from bonding in unwanted areas.*
57. Bond the Leading Edge Wrap and Upper Root Wrap to the Leading Edge Spar. Refer to **FIGURE 05C-57** Use a long straight board (1x2x144") and several (6 minimum) "C" clamps (or similar devices, RANS uses Stanley brand cushioned quick clamps) to retain the Wrap in position until the adhesive cures. A piece of wax paper between the board and the Wraps will prevent bonding the board to the Wraps. Placement of the board and clamps on the Wraps when clamping is critical so as not to deform the Wraps. Clamp only to the bonded area. See **FIGURE 05C-57**.
58. Bond the AFT end of the Upper Root Wrap to the Trailing Edge Spar. Clamping is not necessary as 2-inch wide masking tape works well to hold the Upper Root Wrap to the Trailing Edge Spar during bonding.
59. After the epoxy has cured, remove the clamps, tape, and board. Clean off any excess epoxy from the Wraps and Spars. If not already previously done, rivet the Leading Edge Wrap to the Ribs and Upper Root Wrap. Use a small amount of body putty to form a smooth transition from the Wrap to the Spar. See **FIGURE 05C-59**. Carefully sand excess body putty to profile.

PITOT AND STATIC SYSTEM INSTALLATION - WING**(AFTER WING FRAME ASSEMBLY)**

NOTE: The Pitot and Static Lines and the Pitot/Static Probe Assembly are located in the left wing only.

60. Temporarily install the Pitot/Static Tube through the previously drilled 3/4" hole in the left Wing Leading Edge Spar. Refer to **WING SPAR ASSEMBLY**. Position the Mount Angle to the outboard side of the Pitot/Static Tube on the AFT side of the Leading edge Spar, with the long portion against the Pitot/Static Tube. Transfer drill #11 through the single hole of the Mount Angle. **HINT:** Clamp the mount angle to the Pitot/Static Tube for a tight fit when drilling. Rivet Mount Angle to Leading Edge Spar.
61. Remove Pitot/Static Tube. Modify and assemble per **FIGURE 05C-61**. **CAUTION:** Drilling too deep into the Pitot/Static Probe Fitting may cause damage to Pitot/Static operated instruments.
62. Probe Assembly will be final installed after covering and paint.
63. Route the Pitot and Static Lines as per **FIGURE 05C-63**. The lines should be long enough to allow connection to the AFT end of the Pitot/Static Probe Assembly and should extend out of the AFT side of the Wing Root approximately 3" at this time.
64. Use the pre-located hole in each Rib per **FIGURE 05C-63**. Wrap the Pitot and Static Lines with Anti-chafe Tape and secure to the Rib with Safety Wire.
65. Secure the lines with plastic ties as shown, to the Inner Drag Brace. **NOTE:** Secure the Pitot and Static Lines together with the Flap Teleflex Cable to the Inner Drag Brace. Refer to **FLAP TELEFLEX CABLE INSTALLATION - WING**.
66. **IMPORTANT:** Make sure the ends of the Pitot and Static Lines are cut square. Install the two 90-degree Union Elbow fittings to the Pitot/Static Probe Assembly side (outboard end) of the lines only. **NOTE:** To install the fitting, press it on and then **PULL** to seal. Make sure the fittings are pressed on firmly (line will penetrate fitting about 5/8"). Then **PULL** the tubing to seal. To disconnect the fitting, push the small ring of the fitting as you pull it off. Reference also **FIGURE 05C-63**.
67. Do not install fittings to the root end of the Pitot and Static Lines at this time. Install these fittings after the AFT Root Rib Closeout is installed.
68. Remove the Pitot/Static Probe Assembly for covering and painting. Tape the line ends closed and mark respective ends with "**PITOT**" and "**STATIC**" as per **FIGURE 05C-63** for ease of identification during final installation.

FLAP TELEFLEX CABLE INSTALLATION - WING

(AFTER WING FRAME ASSEMBLY)

69. Route the Flap Teleflex Cable as per **FIGURE 05C-69** and secure with plastic ties as shown to the Compression Tube and Inner Drag Brace.
NOTE: *In the Left Wing, the Pitot and Static Lines secure together with the Flap Teleflex Cable to the Inner Drag Brace.* Refer to **PITOT AND STATIC SYSTEM INSTALLATION - WING**.
70. Push the flap cable inside the wing frame for covering.

S-7S AILERON AND FLAP ASSEMBLY AND INSTALLATION

ASSEMBLY

(BEFORE COVERING)

1. Aileron and Flap Frames are factory assembled.
2. Install nut plates for the hinges to the AFT side (inside) of the Flap Frame Leading Edge Spar before covering. **NOTE:** *Aileron Frames do **NOT** require nut plates for hinge attachment.*
3. To install nut plates, temporary insert a bolt through the hinge hole into a nut plate. Drill # 40 using the nut plate as a guide and rivet. **IMPORTANT:** *Before drilling, be sure the nut plate is aligned with the frame spar.* Using this method will assure a perfect fit.
4. The Flap and Aileron Frames are now ready for covering. Refer to **COVERING**.

(AFTER COVERING AND PAINT)

5. Use a hot iron (a soldering iron or wood burning tool works well) to burn holes through the fabric at the attach points for the Flap Hinges, the Flap and Aileron Attach Angles and through Drain Grommets. Refer to parts pages and **FIGURE 05D-05**.
6. Bolt Hinge Brackets to leading edge of Flap Frame.
7. Aileron Hinges must be bolted to the Wing Trailing Edge Spar before bolting to the Aileron Frame. **IMPORTANT:** *Be sure to check the orientation of the Aileron Hinge.*
8. Bolt on Flap Horn Attach Angles and Aileron Attach Angles. **NOTE:** *Flap and Aileron Attach Angles are orientated 90 degree to the Aileron or Flap Leading Edge.* You will have to fabricate small bushings as per parts manual. Locate and burn small holes through the fabric at the bushing locations. Refer back to **FIGURE 05D-05**. **NOTE:** *Flaps require two Attach Angles, whereas Ailerons use only one.* See **FIGURE 05D-08**.

INSTALLATION

(AFTER COVERING AND PAINT OF WINGS)

9. Install Flaps and Ailerons as per parts manual. **NOTE:** *Flap Hinges are placed on the root side of the Trailing Edge Spar Hinges. Refer to **FIGURE 05D-09.***
10. Tighten the castle nuts only to take out excessive play to avoid friction in the hinge point. **NOTE:** *It may be required to use additional washers to take out the play between Wing and Flap Hinges. Check the Flap for free-movement and adjust nuts if required. Install cotter pins and lubricate all hinges with light machine oil. **HINT:** *With the bolt pushed in tight, the washer next to the nut should have a slight amount of movement.**
11. Do **NOT** connect the Teleflex Cable or Aileron Push-Pull Tubes at this time.
12. Move Flaps up as far as possible and secure in place with masking tape. This will expose the AFT surface of the Trailing Edge Spar for the Gap Seal installation.
13. The PVC Gap Seal material may be used in its natural white color. For details about the installation, refer to **FIGURE 05D-13.**
14. Measure the distance between the Hinges and cut the Gap Seal to length with 45-degree miters on each end. See **FIGURE 05D-13.** **HINT:** *Cut the ends square then use a disk sander to miter the 45-degree ends.*
15. Position the Gap Seal so that it is centered between the Hinges and lined up with the hinge line. See **FIGURE 05D-13.** **HINT:** *Use double-sided tape to temporarily hold seals in position. Where a Bolt Head will not allow the Gap Seal to rest flat against the Trailing Edge Spar, drill a 5/8" hole to allow clearance of the Bolt Head. See **FIGURE 05D-13.** **HINT:** *Place Masking Tape between top edges of the Hinges and use a Straight Edge to mark a line to help keep the Gap Seal straight.**
16. With Gap Seal off of the wing pre-drill #40 each piece of Gap Seal off of the wing as shown in **FIGURE 05D-13.** Hole and rivet locations for each piece of Gap Seal will vary according to length. Maintain a 3/4" edge distance on each end and an 8" to 10" rivet spacing thereafter. Maintain a 5/16" edge distance to the bottom of the Gap Seal to allow for riveting.
17. With Gap Seals positioned on the Wing, transfer drill #40 into the Trailing Edge Spar and cleco in place. Drill out all holes to #30. Remove the Gap Seal, debur and remove all shavings. Install Rivets as per parts manual.

18. The Flaps must move freely without rubbing on the Gap Seals. A minimum clearance of 0.060" must be maintained between Gap Seal and Flap Leading Edge. Final fit the Gap Seal by filing, sanding, or planeing until proper clearance is obtained. **HINT:** *A miniature Wood Plane works great to shave off excess material.*
19. Trim the Aileron Push-Pull Tube Exit and Flap Teleflex Cable Exit to lay flat on the Wing. Trim out the AFT opening of the Aileron Push-Pull Tube Exit. Refer to **FIGURE 05D-19**. **NOTE:** *Cutouts in the Flap Cable Exit will be made during **WING INSTALLATION**.*
20. Center the Exits on the Exit Reinforcement Rings on the Wing. Transfer drill #40 through the dimpled locations on the Exits. Cleco as you drill. Do **NOT** install the Exits at this time. For Exit installation and connection of Aileron Push-Pull Tubes and Flap Cables refer to **WING INSTALLATION**.

S-7S LIFT STRUT ASSEMBLY

INSPECTION OF STRUTS

RANS airfoil lift struts are made of extruded Aluminum. Extrusions of this nature are sensitive to deformation. Cracks and splits can occur along the length of the strut if the ends are compressed beyond the material limits. Over-tightened bolts can cause cracking.

Each piece of strut material is inspected before shipment to assure you of a quality product. We encourage you to inspect your struts for any deformation or surface imperfection. Deeply grooved struts should not be used and returned to the factory for replacement. The surface should look and feel smooth.

Dents and nicks can occur during shipping. The strut material is very thick skinned and resistant to dents. If dents are present they will usually be large enough to require rejection of the material.

Minor nicks and scratches can and should be sanded out with 250, 350, and finally 400 grit wet or dry sandpaper. Sanding out such defects is an effective way of restoring the strut to a safe full strength status. Any nicks or scratches that require more than light sanding are cause for rejection.

Once the struts are in service, continued inspection is the only required maintenance. Anodized strut material is resistant to corrosion and needs little care.

Include strut inspection in your pre-flight.

ASSEMBLY

1. The **S-7S Courier** Lift Struts are cut to length and pre-drilled at the factory. Locate FWD and AFT Lift Struts and mark with "LEFT" and "RIGHT" on a strip of Masking Tape. Refer to **FIGURE 05E-01**. At this point it does not matter which one is left or right. The marking will help you to remind yourself to build a left and right set of Struts. Left and right is determined by the direction the Bolts go through the Struts (top to bottom). Refer to the parts manual. **NOTE:** *The struts are teardrop shaped. The round side is forward.*
2. Smooth the ends of each Lift Strut with fine Sand Paper as per **FIGURE 05E-01** and debur.

3. **NOTE:** Due to dimensional variation in extruded material, it may be necessary to shim the Strut Fittings. No gap should exist between the Fittings and the Struts. **CAUTION:** If a gap exists, do **NOT** eliminate by tightening down the Bolts. This action may crack the Struts. Instead fabricate and use the 0.020" shim material between the fitting and the strut. Refer to **FIGURE 05E-03**.
4. Step Drill the lower hole only on each Upper and Lower Gusset Plates to 5/16" as per **FIGURE 05E-04** for attachment to Lift Strut. The other attachment holes need to remain # 30 at this time.
5. Temporary bolt and cleco Upper and Lower Gusset Plates to both Forward Struts as shown in **FIGURE 05E-04**. Mark Gusset Plates to assure they end up in the same place when final riveting.
6. Remove one cleco at the time and drill out the 3 attachment holes on top and bottom to #11. Cleco as you drill.
7. Remove Gusset Plates. Debur Struts and Gusset Plates.
8. Re-install Gusset Plates with Bolt and clecos. Remove one cleco at a time and rivet with Stainless Steel Rivets (CCPQ-64).
9. Check the fit of Upper Strut Fittings on the Strut Attach Plates on the Wing. File out the inside of the fitting as required until the fitting slides onto the Strut Attach Plate. **IMPORTANT:** Do **NOT** file on the Strut Attach Plate.
10. Install Upper and Lower Strut Fitting as per parts manual in both FWD Struts. Shim if required. Make Left and Right (note direction of bolts). **NOTE:** Fittings may require drilling of holes to match bolt diameters.
11. Cut and install Spacer Bushing in Rod End.
12. Drill out Gusset Plates where Rod End of AFT Lift Strut attaches to 5/16" and check fit of Rod End.
13. Install Upper and Lower Strut Fittings in both AFT Struts. Shim if required. Upper AFT Connector will require modification to allow pivoting to proper attachment angle when installed. Refer to **FIGURE 05E-13**. **NOTE:** Fittings may require drilling of holes to match bolt diameters.
14. Install Eyebolts in Lift Struts for attachment of Jury Struts. Do **NOT** Tighten at this time as Eyebolts will require pivoting to align with Jury Strut Assembly.
15. For Lift Strut installation, refer to **WING INSTALLATION** and **RIGGING**.

S-7S WING TIP ASSEMBLY AND INSTALLATION

WING TIP FIT UP AND ASSEMBLY

(AFTER COVERING AND PAINTING OF WINGS / AFTER INSTALLATION OF AILERONS AND FLAPS)

1. When fitting the Wing Tip, work carefully not to scratch the paint on the Wing. The Wing Tip will need additional trimming and sanding, before the surface finish can be applied.
2. Use a hot iron to burn a small hole through the fabric at each hole along the Tip Rib.
3. Slide the Wing Tip all the way onto the Wing.
4. It will be necessary to trim the Wing Tip to within 5/16" of the centerline of the Tip Rib. Trim the Wing Tip to allow for sufficient clearance to the aileron. Refer to **FIGURE 05F-04**. Tape the Wing Tip in place to avoid movement.
5. Use a hole-finder to mark and drill #40 holes in the Wing Tip to match the pre-drilled holes in the Tip Rib. Cleco as you drill making sure the Wing Tip fits tightly.
6. Slide the AFT Closure (small metal rib) inside the AFT end of the Wing Tip and clamp in place. Mark 3 holes top and bottom on the Wing Tip approximate centered on the Rib Flange and drill # 30. Rivet the Aft Closure in place. **NOTE:** Use the metal rib to align the tip's aft end with the aileron neutral setting. Refer to **RIGGING** section.
7. Remove the Wing Tip, final trim, prep, prime and paint.

FINAL INSTALLATION

(AFTER PAINTING OF WING TIPS)

8. Add a length of clear plastic tape along the Tip Rib on the Wing as an anti-chafe provision.
9. Secure the Wing Tip to the Tip Rib using small screws called out in the parts manual.
10. Check for clearance between tip of aileron and wing tip as per **FIGURE 05F-04**.

S-7S ROOT SKIN INSTALLATION

INSTALLATION

(AFTER PAINTING OF WINGS)

1. Apply desired finish to Root Rib Closeouts.
2. Final install Root Rib Closeouts and Fuel Sight Gauge parts before the Wings are mounted to the aircraft.
3. Refer to ROOT SKIN parts page and place Grommets and Serrated Strip in correct locations in FWD and AFT Root Rib Closeouts. **HINT:** *Cut Serrated Strip slightly long and trim to length to help hold in place.* A few drops of Super Glue on the outboard side can also help if required. Refer to **FIGURE 05G-03**. **NOTE:** *The two Small Grommets are installed only in the left AFT Root Rib Closeout for the Pitot and Static lines.*
4. Be sure all hardware is installed in fuel tanks for Fuel Withdrawals and Fuel Sight Gauges. Cleco Root Closeouts to Root Rib. Position Sight Gauge Decal centered between the Grommets. Refer to **FIGURE 05G-04**.
5. Install the Tee Fitting for the upper end of the Sight Gauge. Install the 90-Degree Withdrawal Fitting for the lower end of the Sight Gauge. Orientate each fitting to align to each other. Fabricate the Sight Gauge from the supplied Clear Fuel Line. Refer to **FIGURE 05G-05**.
6. Rivet FWD Root Closeout skin in place.
7. Route the Flap Teleflex Cable, Fuel Line, and Pitot / Static lines through the Grommets in the AFT Root Closeout.
8. Attach Aft Closeout with screws.
9. Final install the Fuel Lines from the Wing to the Fuselage after the Wings are mounted. Refer to **FUEL LINE INSTALLATION - FUSELAGE** for instructions.

S-7S WING INSTALLATION

Please read the entire section before you continue with Wing Installation.

We recommend having all assemblies and installations related to the Wing completed before the Wings are final installed to the airplane. It is **NOT** necessary to trial-fit the Wings to the Fuselage at an earlier assembly stage.

The following items should be completed at this stage:

- Wings are painted
- Ailerons, Flaps and Gap Seals installed
- Aileron and Flap Cable Exit Fairings trimmed and fit to Wing
- Wing Tips painted and installed
- Wing Root Rib Closeouts (root covers) painted and installed
- Fuel Sight Gauges installed to Wing root
- Lift struts assembled

All of the above items are easier to do with the Wing on sawhorses than on the airplane.

It is recommended to hang both Wings at the same time (one at a time). You will need at least one helper. However, it is more comfortable to have two helpers.

Refer to **parts page 005-01**.

1. Drill out the 1" U-Brackets (stainless steel) to fit a 5/16" Bolt. Drill the attach hole to the Fuselage only.
2. Bolt the 1" U-Brackets at the Left and Right side of the Fuselage to the bushings at Station 3. Use hardware as shown in the parts manual.
3. Install the Hinge Cubes as shown in the parts manual to the Trailing Edge Spar Root Fittings. **NOTE:** *The slotted portion should bolt to the 1" U-bracket.*
4. Rest the wing on 2 saw horses besides the fuselage.
5. Previously the Lift Strut Fittings should have been checked for fit on the corresponding Strut Attach Plates on the Wing. If not, use a fine file or sandpaper to remove as little material as possible. **IMPORTANT:** *Remove material only from the fittings, NOT from the Strut Attach Plates.*
6. **IMPORTANT:** *The FWD attachment hole in the Leading Edge Spar and Spar Patch should have been drilled to 3/8" during Leading Edge Spar assembly. If not, refer back to WING SPAR ASSEMBLY and do so now.*
7. Modify the FWD end of the Carry-Thru Bushing ("T"- Bone) per **FIGURE 05H-07**.

8. Modify both ends of the Fuselage Carry-Thru Bushing (“T”-Bone) to fit tight in the Leading Edge Spar of the Wing. Refer to **FIGURE 05H-08**. The “T”- Bone must be contoured with a file to follow the inside shape of the Spar. Check fit by temporarily attaching the Wing at the Trailing Edge to the U-Bracket on the Fuselage and sliding on the Leading Edge Spar. Remove Wing. Check fit of attachment bolt in “T”-Bone and debur the filed area. **IMPORTANT:** *It is recommended to apply some corrosion protective primer to the bare metal.*
9. With the assistance of helpers, lift the Wing into position. Have a helper on the Wing’s tip end and one on the root end of the Trailing Edge Spar. Slide the Wing’s Leading Edge Spar onto the “T”- Bone. Feed all cables into the Fuselage. Bolt the Hinge Cube to the U-Bracket at the trailing edge using the hardware shown in the parts manual.
10. Temporarily insert the forward wing attach bolt through the Leading Edge Spar into the Wing Carry-Thru Bushing.
11. Connect the FWD Lift Strut to the Strut Attach Plate at the Leading Edge Spar.
12. Raise the tip of the Wing as needed to allow the fitting at the lower end of the FWD Lift Strut to slide into the Fuselage bracket. Insert bolt.
13. Drill the AFT hole in the Leading Edge Spar at the Wing root to fit the 3/8” bolt. A helper is required to hold the wing secure at the wing tip, while drilling. Below is two ways of drilling the AFT hole. You may decide which one you use. RANS’ Assembly Crews have done it both ways, but Method #2 is recommended.

METHOD #1:

Remove the Leading Edge Spar Attach Bolt. Use the “T”-Bone as a guide and transfer drill through the aft wall of the spar in one-step to 3/8”. **CAUTION:** *It is very important, to hold the wing completely stationary while drilling the AFT hole. Otherwise, hole elongation will result.* Preferably use a bit with a short cutting area (reduces the danger of elongation in the front hole).

METHOD #2:

Fabricate a drill bushing from a tube with 3/8" O.D. and an I.D. to fit a long drill bit you have (a long #11 or 1/4" bit will work well). The bushing should fit tight in the "T"-Bone and extend long enough out of it to allow pulling it out. RANS uses a steel bushing with a welded on handle. Lubricate the bushing for ease of removal and insert through the front of the Leading Edge Spar and the "T"-Bone until bottomed against the inside of the Leading Edge Spar. Drill through the Leading Edge Spar with the long drill bit using the drill bushing as a guide. After drilling pull the drill bushing out about 1/5" and drill through the AFT end of the Spar to a size short of 3/8". Remove the drill bushing completely and blow out the interior of the "T"-Bone. Holding the Wing steady, insert a 3/8" drill bit through the FWD end and drill out the AFT wall of the Spar to 3/8". **CAUTION:** *It is very important, to hold the wing completely stationary while drilling the AFT hole. Otherwise, hole elongation will result.* Preferably use a bit with a short cutting area (reduces the danger of elongation in the front hole).

14. Insert Leading Edge Spar Attachment Bolt and tighten. Tighten bolt enough to take out play
15. Connect the upper end of the Aft Lift Strut to the Lift Strut Plate at the Trailing Edge Spar.
16. Temporarily install the Rod End in the lower end of the AFT Lift Strut between the Gusset Plates on the FWD Lift Strut. Pin only at this time using the bolt. Do **NOT** forget to insert the bushing in the Rod End. **NOTE:** *The Rod End on the lower end of the AFT Lift Strut is used to set the Wing washout during rigging. Refer to **RIGGING** for information. **NOTE:** Both wings must be installed to the Fuselage before washout is set.*
17. After washout is set, tighten and check all Strut connections.
18. Apply desired surface finish to Jury Struts and install.
19. Support Lift Struts with a block of wood or similar material about halfway down to straighten them. The weight of the Wing causes a slight bend. Look down the Strut to get a good idea if the struts are straight.
20. Bolt the Jury Strut Assembly in place as shown in the parts manual. Should you not be able to achieve proper fit, then it is possible to space the eyebolts up with washers. You can also use washers at the drilled head bolt locations if needed. Use Loctite and safety wire the drilled head bolts in place. Tighten all attachment bolts and nuts.

21. Temporarily bolt the upper end of the AFT Jury Strut to the Teleflex Retainer Bracket. Use the tab on the AFT end of the Jury Strut Assembly to mark the lower end of the AFT Jury Strut. Drill using a #11 bit. Bolt the lower end of the AFT jury strut to the tab.
22. Disconnect the upper end of the AFT Jury Strut and modify the Flap Cable Exit Fairing as required. Refer back to **FIGURE 05D-19** to allow for the Flap Teleflex Cable, and the AFT Jury Strut. Also, drill a # 30 hole at the lowest point of the Fairing as a drain.
23. Slide the Fairing on the AFT jury strut and bolt the upper end of the AFT Jury Strut and the Flap Teleflex Cable in place. Secure the Fairing to the underlying reinforcement using the supplied small screws.
24. Tighten and check all connections.
25. Refer to **parts page 002-07 and FIGURE 02-11**. Connect the Aileron Cable as shown. Refer to **RIGGING** for information about Bell Crank position and cable tension.
26. Connect Push-Pull Tube to the Bell Crank Arm. Slide the Exit Fairing on the Aileron Push-Pull Tube. Temporarily connect Aileron Push-Pull Tube to the Aileron Horn. Adjust the Push-Pull Tube with the Control Stick centered for the correct Aileron neutral position as per **RIGGING** instructions.
27. Route the Flap Teleflex Cable inside the Fuselage as shown in **FIGURE 05H-27**. Route each Flap Teleflex Cable through the opening in the Baggage Compartment at Station 3. Both Cables route along the bottom of the Fuselage and connect to the Flap handle.
28. Connect the Flap Cable to the Flap Horns on the Flaps as shown in the parts manual. For adjustment of the Flaps, refer to **RIGGING**.
29. Fabricate the Fuel Lines to connect the Wing Fuel System to the Fuselage Fuel System. Refer to **FUEL LINE INSTALLATION FUSELAGE**.
30. Refer to **FIGURE 05H-30**. Position the Wing Root Gap Seal on the under side of the Wing so that the flange is tight against the Fuselage frame. Use a hole finder and locate the holes in the Root Rib with the Tinnermans. Mark and drill #30.
31. Remove the gap seal and paint. During final assembly, glue the small foam tape to the flange that will rest against the fuselage frame. Attach the gap seal to the wing with the screws provided.
32. Temporarily install the fillet flap to the fuselage. **NOTE:** *The fillet flap is installed to the welded tabs behind Station 3 and closes the gap between Fuselage covering and Flap.* Final installation will be done after **WINDSHIELD INSTALLATION**.

33. Install the assembled Pitot/Static Tube through the previously drilled 3/4" hole in the left Wing Leading Edge Spar. Refer to **WING SPAR ASSEMBLY**. Position the aft end even with the end of the Mount Angle and secure with two hose clamps. **NOTE:** *Be sure the end of the Pitot/Static Tube is downward in relation to the wing.*
34. Connect Pitot and Static lines to their respective connectors in the wing.

S-7S BOOT COWL AND INSTRUMENT PANEL INSTALLATION

BOOT COWL FIT-UP

(AFTER COVERING AND PAINTING OF FUSELAGE)

NOTE: *The Boot Cowl must be fit-up and drilled to the fuselage frame before the surface finish can be applied.*

1. It is recommended, to do this after the fuselage is covered and painted and the gear is installed. The forward floorboard should **NOT** be installed at the time of fit-up. To fit-up the Boot Cowl it is also necessary, that the firewall and the aft engine mount be bolted to the fuselage frame.
2. Modify Boot Cowl Closeout per **FIGURE 06-01**.
3. Trim Boot Cowl per **FIGURE 06-02**.
4. Slide the Boot Cowl from the front onto the fuselage frame. Mark, trim and drill Boot Cowl as shown in **FIGURE 06-02A, 06-02B, and 06-02C**. The Boot Cowl should fit as tight as possible to the front face of the firewall.
5. Drill the 3 tabs on Station 1-A bottom crossing tube to #11. Transfer drill #11 through the Boot Cowl. Cleco.
6. Install the Boot Cowl Closeout as per **FIGURE 06-02B**. Note the orientation of the Closeout. Drill #30 to welded frame tabs. **IMPORTANT:** Do **NOT** drill through Boot Cowl at the Tabs. Transfer drill through Boot Cowl Closeout and Boot Cowl. Remove Closeout and glue small Rubber Edging to aft side. Rivet Closeout to frame tabs. **NOTE:** Rivets are installed from inside out. **IMPORTANT:** Do **NOT** rivet the Closeout to the Boot Cowl at this time.
7. If installing a transponder you may want to use the suggested location. Mark and drill the transponder antenna mounting holes per **FIGURE 06-02B**. Use the template, which comes with your Transponder Antenna for proper mounting holes. **NOTE:** This may be done after the Boot Cowl is removed and before painting. It is suggested to manufacture and bond a Transponder Ground Plane to the inside of the Boot Cowl with DP-460 Adhesive.
8. Transfer drill Boot Cowl to top of firewall in 8 places as shown in **FIGURE 06-02A** and cleco.
9. **HINT:** Only mark the locations for the receptacle hole. Mark the hole location with a length of masking tape extending past the cowl joggle. Refer to **FIGURE 06-02A** and **parts page**. Install the receptacles around the joggled flange as shown.

10. The receptacles should be approximate centered on the cut outs in the firewall. To install the receptacle, drill a # 11 hole and cleco the receptacle in place. Transfer drill the two # 40 holes through the receptacle. Countersink the # 40 holes to allow the rivet heads to be flush with the outside of the joggle surface. Drill out the #11 hole to 5/16" and rivet the receptacle to the inside of the Boot Cowl.
11. Re-install the Boot Cowl to the fuselage frame and secure with clecos.

VERTICAL INSTRUMENT PANEL FIT UP

12. A blank instrument panel is provided with the kit. The builder should design and cut his own instrument and switch holes in the panel or contact a commercial aircraft panel manufacturer. **IMPORTANT:** *Check instrument clearance to the frame tubes before cutting instrument mounting holes.* Double-check your design before cutting the panel.
13. Refer to **FIGURE 04-02** and use the provided full size template to mark and drill the four 5/16 holes in the left side of the instrument panel. The control cables will mount as shown during final assembly.
14. Cleco the Instrument Panel to one Vertical Instrument Panel Frame. Transfer drill Panel mount holes to #11. Un-cleco panel and rivet nutplates to Panel Frame.
15. Position the remaining un-drilled Vertical Instrument Panel Frame (flange facing AFT) against the Boot Cowl flange. The Panel Frame should set nearly flush with the top of the Boot Cowl. Transfer drill #11 through the top center hole and cleco. Transfer drill #11 through 4 of the remaining mounting holes. Cleco as you drill. Refer to **FIGURE 06-03A**. **NOTE:** *Skip every other mount hole. Remove Frame and rivet nutplates to AFT (flange side) of frame.* Temporarily Bolt to flange of Boot Cowl.
16. Cleco Panel Dash to Panel Frame drilled for Instrument Panel. Position assembly per **FIGURE 06-03B**. Allow forward end of Panel Dash to rest against Frame bolted to Boot Cowl. Transfer drill #30 through the lower fuselage tabs and cleco Panel Assembly in place.
17. Mark the underside of the dash where the forward frame tab holes are. **HINT:** *A hole finder will work well here.* Transfer drill #40 through tab holes and cleco. Final size #30. It may be necessary to trim the forward edge of the dash to clear the Boot Cowl.
18. Check that the panel and dash clear all fuselage tubes. This is important to avoid the transmission of vibration. Some trimming for clearance might be required.

19. If installing panel-mounted radios, set-up the radio supports (side plate mounts) at this time. The aft end of the radio supports will be riveted to the instrument panel. Trim the forward ends as needed to clear Station 1. Attach the forward end to the two diagonal frame tubes, under the supports, with cushion clamps. Use the radio's mount tray to set the width of the supports and determine the panel opening. The exact details of the installation will depend on the radios.
20. Modify Panel Closeouts per **FIGURE 06-03C**. Orientate cut FWD. Slip over fuselage tubes and center. Transfer drill #30 to Panel Dash. Do **NOT** rivet to Dash until Final Assembly.
21. Remove dash and place on a flat surface. Using contact cement spray (3M SUPER 77 Multipurpose Spray Adhesive may be used) glue foam to Dash up to, but not including both rivet hole lines (rivets will be placed under the unglued foam and fabric in a later step) and allow to dry. Allow overlap over the edges. Glue Panel Fabric over foam allowing about 1/4" overlap on all edges. **IMPORTANT: Do NOT glue to Dash or foam beyond the mounting rivet holes at this time.**
22. Un-cleco panel and drill all panel mounting holes in the panel to 5/16" to allow for the rubber grommets (vibration isolators) to be installed. Do **NOT** drill the holes in the Panel Frame larger than #11.
23. Remove Boot Cowl. Apply desired finish to inside and outside of Boot Cowl. Prime and paint the outside. Prime and paint the inside. Fabric may also be glued inside to the visible areas.

NOTE: *If concerned about scratching the Boot Cowl, it is recommended to trial fit and drill the windshield and the front trim strip windshield together with the Boot Cowl before the finish is applied. Refer to **WINDSHIELD ASSEMBLY AND INSTALLATION**. The trial fit of the windshield is only possible if the wings are installed. If you work carefully trial fit is not really needed.*

FINAL INSTALLATION OF BOOT COWL AND INSTRUMENT PANEL

24. Cut and finish the instrument panel as desired. **NOTE:** *When laying out the panel, it is important to check that the instruments will clear the fuselage frame tubes under the Dash.*
25. The Boot Cowl should be final installed after the finish is applied and most of the assemblies and installations in the cabin and firewall forward are finished.
26. It is suggested to have the engine installed and the entire engine installation including plumbing and wiring finished. It is also suggested to have the instrument panel including all the instrumentation, radios and electronics installed. It is much easier to perform these installations without the Boot Cowl in place.
27. The muffler extension should not be installed since it will interfere with installing the Boot Cowl.
28. To slide on the Boot Cowl, disconnect the Radiator Support Tube in the front and loosen the mount tang bolts in the rear of the radiator. This will allow you to swing the radiator out of the way.
29. Slide the Boot Cowl on the fuselage and cleco to fuselage frame.
30. **IMPORTANT:** *Apply high-temp Silicone Sealant along the entire forward seam between Firewall and Boot Cowl.* It is recommended to squeeze some Silicon between these parts to achieve a good seal between cabin and engine compartment. This will help prevent leaking fluids or fumes reaching the cabin.
31. Rivet Boot Cowl to fuselage frame and firewall as shown in the parts manual and in **FIGURE 06-02A** to **06-02C**. **NOTE:** *Do NOT rivet to the tangs where the windshield trim strip will mount.* Reference **FIGURE 06-02C** for details.
32. Bolt forward Panel Frame to Boot Cowl. Place dash over Panel Frames and rivet. Using contact cement spray (3M SUPER 77 Multipurpose Spray Adhesive may be used) glue foam to remainder of Panel Dash and allow to dry. Trim to edge with a razor. Glue Panel Fabric over foam allowing about 1/4" overlap on all edges. Wrap excess over edges and glue to secure.
33. Install the Rubber Grommets in the Instrument Panel. Tighten Panel Mounting Bolts only lightly. The rubber grommets are there to provide some vibration isolation, so you do not want them compressed all the way.
34. Apply Rubber Edging to pilot side of Dash. Trim edging to length as needed.
35. Rivet Closeouts to Panel dash. **HINT:** *The rivet heads may be touched-up with black paint if desired.*

36. Check that the panel clears the fuselage frame to avoid vibration transmitted directly to the panel.

S-7S FORMED WINDSHIELD / SKYLIGHT ASSEMBLY AND INSTALLATION

FIT UP

(AFTER WING INSTALLATION)

IMPORTANT: This section does **NOT** go into the detail of trimming and drilling your Windshield, as there are volumes written on this already.

More information may be found at <http://www.plexiglas.com/>. Both the literature and the viewing software are free.

Installation of Wing Cuffs requires 3M 2216 Adhesive.

NOTE: The wings must be attached to the fuselage prior to the windshield fit up. That is necessary to set the height of the three windshield supporting ribs and to assure that the windshield/skylight lays flat on top of the wing. It is also required that the boot cowl is installed.

1. Extra care should be taken when working with Lexan or Acrylic. Lexan scratches easily. Acrylic can break easily. As much as possible of the protective plastic should be left in place until the aircraft is ready to be flown.
2. The windshield will require some trimming.
3. With the wings attached to the fuselage, position and tape at least two straight edges from wing root to wing root as shown in **FIGURE 06-04**. **NOTE:** The straight edges used should only rest about 1" on the wing. The tape will help to keep them in place, while fitting the support ribs. The straight edges will be used to set the height of the windshield ribs level with the wing root.
4. Drill #30 the outer windshield tabs located on the leading edge spar carry-thru. See **FIGURE 06-04**. Countersink to allow the use of flush rivets.
5. It is possible that the skylight ribs require some minor forming to follow the contour of the wing root.
6. The skylight ribs mount to the underside of each tab through the outboard hole. Slip outer ribs into position. Drill at the front end #30 using the tab as a guide and cleco.

7. Bring the ribs up to contact the straight edges. Place the outer rib to the outside of the standoff tube. Drill outer ribs # 30 using the standoff tubes as a guide and cleco. Drill outer ribs # 30 at the aft end through the fuselage tabs (rib mounts to the outside of tab). Cut outer ribs off just aft of the aft attach tab.
8. Drill the center tab located at the leading edge spar carry-thru at its center to #30 and countersink. The center support rib mounts to the underside of the tab.
9. Transfer drill center rib # 30 through the tab and cleco in place. Bring the rib up to contact the straight edges. Place the rib to the left side of the standoff tube. Drill #30 using the standoff tube as a guide and cleco. Mark the aft end, so that it will slip on the stub welded at the top of station 3. Check, mark and cut off. Slide the aft end on the stub and drill a #30 hole from the bottom through the rib and into the stub. Reference also **FIGURE 06-04**.
10. **NOTE:** *It is possible that the standoff tubes extend past the top of the support ribs and must be cut off. See **FIGURE 06-04**. Leave ribs clecoed in place for now.*
11. Burn small holes through the fabric at the locations of the 4 tabs on the aft top of station 3. The skylight will later be riveted to these tabs.
12. Lay the acrylic windshield in place on the aircraft. Establish the trim lines where the windshield meets the boot cowl. A Dremel tool with a fiber-reinforced cut-off wheel works well. Sand the edges smooth with a sanding block. Start with 120 grit and work progressively to a finer grit.
13. Pull each side of the windshield down tight against the boot cowling and fuselage side tubes and clamp or tape in position. See **FIGURE 06-06**. It may be necessary to trim the forward edge of the windshield to achieve the proper fit inside the top joggle of the boot cowl.
14. Find the center of the boot cowl and mark. With the windshield tight in the joggle of the boot cowl, position the front trim strip so that the aft edge of the hold down strip is flush with the instrument panel. The strip should lay flat against the windshield and the boot cowl with no puckers. The hold down strip is retained to the boot cowl only. Do **NOT** locate rivets into windshield. Position the center hole in the hold down strip on the centerline of the boot cowl and transfer drill through the strip into the boot cowl and cleco in place. Pull the hold down strip tight to the windshield and boot cowl. Transfer drill #30 through the holes in the strip. Drill from the center out alternating from side to side. Cleco as you go. Push the sides of the trim strip and the windshield down and transfer drill from the inside of the fuselage through the 4 tabs at each side, the boot cowl and the trim strip. Cleco as you go from the fuselage outside. **NOTE:** *The windshield sides are sandwiched between "Z" strips and trim strips. Do **NOT** drill or rivet into the fuselage structure or windshield.*

15. Cut away a small portion of the protective plastic coating from the perimeter of the windshield. Cleco the Trim Strip Spacer to the "Z" Strip. Position the "Z" strip to the upper fuselage door frame tube on the inside of the fuselage so that the drilled flange is flat against the windshield and the cupped portion is capturing the tube. See **FIGURE 06-06**. Hold the windshield and "Z" strip assembly tight against the fuselage frame. Mark on the Windshield the forward edge of the Trim Strip Spacer. Trim material from Windshield to mark, to allow the Trim Strip Spacer to set aft and flush with Windshield. See **FIGURE 06-06A**.
16. Cleco Windshield Trim Strip, "Z" strip and Trim Strip Spacer in position on the door frame. **NOTE:** *The lower end of the trim strip will be riveted together with the boot cowl and the front trim strip to the rear most tab on the fuselage frame.* Transfer drill through the tab and cleco.
17. All parts should stop short of the centerline of the door frame tube to allow for the door.
18. Modify the lower side edge of the forward trim strip for better fit as shown in **FIGURE 06-06**. Trim the Windshield Trim Strip as needed at the top.
19. The Acrylic windshield will be mated to the Lexan skylight with upper and lower mating strips. Refer to **FIGURE 06-06B** for drilling the ends of mating strip assembly. Cleco Mating Strip Spacer between Mating Strips making sure the forward side is tight against the aft edge of the windshield.
20. Mark support ribs 1/4" aft of mating strip.
21. Position FWD hold down strip with hold down strip spacer forward of mating strip along edge of windshield. Transfer drill #30 into wing and cleco. **CAUTION:** *Use a drill stop and do NOT drill into fuel tank.*
22. Locate and drill the holes on top centerline of each rib as shown in **FIGURE 06-05**. Remove support ribs from fuselage frame to allow easier drilling. Do **NOT** drill completely through the ribs, but only through the top surface of the rib. After all holes are drilled, re-install the support ribs and rivet per parts manual. Use a stainless steel rivet at the aft end of the center rib.
23. Slide Skylight between Mating Strips making sure it is centered side to side and is tight against Mating Strip Spacer.
24. Mark and remove the protective plastic along each skylight rib. Starting at the forward hole, working your way aft and alternating from side to side, drill #30 through the skylight into each hole in the ribs. Cleco as you go. Do **NOT** Drill into the Windshield!!
25. Transfer drill through the aft skylight tabs on the station 3 top cross tube through the skylight. Lay the skylight aft trim strip under the skylight so that the holes are in the center of the trim strip. Center the trim strip from side to side. Transfer drill through the holes through the trim strip. Remove

- trim strip and place on top of the skylight. Cleco in place. **NOTE:** *The left outboard tab also captures the antenna plate for the ELT.*
26. Remove Skylight and drill all #30 holes in skylight to #28 and deburr. Do **NOT** drill the holes in the ribs larger than #30. Cleco skylight back in place.
 27. Lay the three top skylight trim strips in position and cut to length. Each strip will run forward from the aft hole on the skylight rib to the aft side of the mating strips. Cut strips to length and place beside skylight ribs to mark hole locations on strips; allow 1/4" between end of strip and first hole. Remove the strips and drill #30 on center line. Cleco the strips in position to check for fit. Mark skylight trim strips to identify their position in final assembly.
 28. Trim wing cuffs as in **FIGURE 06-08**. Hold cuffs on windshield and leading edge spar. Find position of best fit for wing cuff, press down firmly against the windshield and tape securely in place. Use a fine point marker and mark the perimeter edge of the wing cuff onto the windshield.
 29. Mark and trim cuffs flush with edge of windshield.
 30. Remove cuff and place 3/4" masking tape on leading edge spar, extending outboard from wing attach bolt. Top edge of tape should be in-line with bolt's centerline. Re-install cuff and mark edge of cuff on tape. Mark top edge of tape on cuff. Remove cuff and measure distance between mark on tape and bolt's center; transfer measurement to cuff and drill 3/4" hole in cuff as per **FIGURE 06-08**.
 31. Check the fit of all trim strips, skylight and windshield at this time. Mark as required for final trimming.
 32. Remove windshield. Sight through the inside of the windshield and mask around marked line of cuffs on inside of windshield. Scotch-brite inside of windshield in this area and paint black. Allow to dry, remove masking and re-install windshield to fuselage. The black painted area will hide the cuff glue area.
 33. Temporarily install the Fillet Flap to the fuselage. The skylight will sandwich between the Fillet Flap and the Flap Fillet Attach Strip. Trim the Attach Strip to Length. Refer to **FIGURE 06-08A**. Drill and rivet the Attach Strip to the Fillet Flap.
 34. Remove the windshield/skylight and all trim strips. Deburr all holes. Apply the desired surface finish to trim strips, "Z" strips, fillet flap and wing cuffs.

INSTALLATION

35. Glue rubber trim to the outside edge of the skylight. Leave the forward end un-glued until trimmed for the mating strips.
36. Apply foam tape to the "Z" strips at the tube contact points as shown in **FIGURE 06-06**. Apply foam tape to the top of the three windshield support ribs as shown in **FIGURE 06-07**. Apply foam tape under the outer edge of the Fillet Flap and install.
37. Apply a small bead of silicon seal in the joggle of the boot cowl prior to installing the windshield and apply a small bead of silicon under the windshield hold down strip prior to riveting.
38. Rivet the skylight, all trim and "Z" strips in place with the appropriate rivets called out in the parts drawing. **NOTE:** *The left outboard rivet at the rear top of station 3 also holds the ELT antenna plate.*
39. Apply tape outside of marked perimeter of wing cuff on windshield. Scuff inside of Wing Cuff with Scotch-brite. Apply 3M 2216 Adhesive to inside of cuff. Carefully apply wing cuff to windshield inside of marked line. Tape in place and use sandbags or similar weight to help press wing cuff to windshield until adhesive dries.
40. Remove weight and tape.
41. It is recommended, to apply a fillet of silicon seal all the way around the front of the windshield (at the edge of the trim strips), around wing cuffs and Windshield mating strips after installation. Apply a suitable masking tape along the edges and another line of masking tape about 1/8" from the edge. Apply a small bead between the tapes and smoothen. Remove masking tape before the silicone hardens. This will aid in preventing the penetration of water and dirt.
42. Drill bottom outboard hole through cuff, into sheet metal, carefully avoiding fuel tank and spar. Refer to **FIGURE 06-08**. A sheet metal screw retains the cuff to wing in this location.

CARE OF WINDSHIELD

43. The windshield is made from Acrylic. Skylight and windows are made from Lexan. **Do not bring in contact with fuel. Fuel may harm these surfaces almost immediately.** If fuel is spilled accidentally, wipe off immediately. Rinse with lots of water, if available.
44. **Always close the doors when you refueling.** Otherwise it is possible that spilled fuel will run around the wing trailing edge and drop onto the open door.

45. Clean the windshield with plenty of water and if you need to, with a mild detergent in low concentration. Rinse thoroughly and dry with a clean soft cloth or towel. RANS recommends "Brillianize" for windshield care. Brillianize is available from RANS Parts Department. **NOTE:** *Never use gasoline, benzine, alcohol, acetone, thinner or glass cleaner on plastic surfaces (windshield, skylight and windows).*

S-7S DOOR ASSEMBLY- LEXAN AND TRIM

(REFER TO PARTS PAGE # 006-06 FOR PARTS SELECTION)

(AFTER COVERING AND PRIMING OF DOORS/ BEFORE PAINT)

Refer to **FIGURE 06-09**

Position the fwd & aft window support tubes as shown in **FIGURE 06-09**. The outer curve will be flush with the outer door frame. Transfer drill #30, top and bottom. Rivet the supports to the door frame.

Clamp the outside perimeter trim strips to the doorframe as shown in the parts manual. **NOTE:** *The inside edge of the trim strips should be flush with the inside of the doorframe tube.* The upper side of the FWD and AFT trim strips should be flush with the top of the doorframe. Mark and trim the excess material from each trim strip as required.

Using a #30 drill bit drill through the trim strips and doorframe. Cleco as you go. Locate and drill additional #30 holes where the trim strips overlap as desired.

With all trim strips clecoed to the doorframe, place the upper and lower window trim strips in position (centered on frame tube). Mark and trim each strip to allow it to fit between the perimeter trim strips. With the window trim strips cut to length drill in the frame tubes using the strips as a guide.

Cleco as you go.

Position the support trim strips centered on the support tubes. Transfer drill #30 and Cleco. Trim the strips flush with the upper and lower window trim strips.

Remove all trim strips and deburr all holes.

Position the inner upper trim strip to the inside of the upper doorframe so that the lower edge of the trim strip is flush with the inside of the doorframe tube. Slide the trim strip forward until the lower forward corner of the trim strip is flush with the forward side of the doorframe tube. Trim the strip to follow the same angle as the forward doorframe.

Drill the doorframe using the trim strip as a guide.

Mark and remove the inner trim strip.

Position the door window centered on the door frame. Trim the outer edge as necessary. See **FIGURE 06-09**. Mark and cut back approximately 1" of the protective plastic where the Lexan rests on a frame or support tube.

Re-position the Lexan on the door frame and clamp in place. Starting at the top and bottom center, transfer drill through the Lexan into the pre-drilled holes in the door frame and support tubes. Cleco as you go.

Remove the Lexan and chase drill all holes in the Lexan only to #28. This will allow for rivet expansion without inducing undue stress into the Lexan.

Re-position the Lexan on the door frame and cleco all trim strips. Check fit of all components.

With the windshield installed on the fuselage, install the door assemblies. Trim the upper forward door trim strip so that there is 1/16" gap between the trim strip and the edge of the windshield. **NOTE:** *There should be a smooth (flush) transition between the windshield and the door trim strip.* The door trim strip does **NOT** overlap onto the windshield. The inner upper trim strip should be on centerline of the upper fuselage doorframe tube. Trim accordingly.

Rivet trim strips in place.

During final assembly, install the vents. Bond the rubber edging onto the top edge of the inner upper trim strip. Install the foam seal to the inside edge of the perimeter trim strips to seal against the fuselage when the door is closed.

Proceed with **DOOR LATCH & DOOR INSTALLATION.**

S-7S DOOR LATCH AND DOOR INSTALLATION

(REFER TO PARTS PAGE # 006-08 FOR PARTS SELECTION)

(AFTER PAINT OF DOORS AND INSTALLATION OF TRIM STRIPS AND LEXAN)

Refer to **FIGURES 06-10** and **06-10A**.

Burn holes through the door fabric at the bushing locations.

Finish all parts as desired.

Bolt the trim lever knob to the door handle. Note that there is a left and right hand door handle and a forward and aft orientation to each. Refer to the parts drawing. Fabricate the aluminum bushings as per the parts page and bolt the door handle assembly to the doorframe.

Install the door pivot bushings into the forward and aft bushings welded to the door frame. Washers may be added or removed later to adjust the tightness of the door seal. Install the forward and aft door latch rods and bolt to the appropriate hole location in the door handle. Refer to the parts drawing. Operate the door handle through its full range of movement. If the door latch rods have a tendency to bind in the pivot bushings, remove the latch rods and with a drift punch inserted into the pivot bushing, tweak accordingly.

Install the bottom latch as shown in the parts drawing. Note that the bottom latch is retained by the outer handle. Adjustments may have to be made to both the bottom latch and to the outer handle. Do not secure them at this time. Bolt the door connect rod to the door handle and the bottom latch. The flattened ends on the door connect rod may need to be bent slightly for proper alignment and a smooth operation. Washer combinations may be altered to gain needed clearance.

Modify the Door Latch Striker Plate tube per **FIGURE 06-10A**.

Pin the door in place on the fuselage. Mark the contact locations of the latch rods onto the fuselage frame. Using the acrylic foam tape, attach the door latch striker plates to the fuselage frame so that the entire contact area is protected by the striker plate.

Position the outer door handle parallel to the slipstream with the door latch mechanism fully closed. Fabricate the aluminum spacer bushings. Refer to the parts page. Note the orientation of the outer handle. Improper orientation will result in loss of use of the door upcatch.

Clamp the outer handle and the inner latch tight together, with the aluminum bushing between them. Using a #40 drill bit, pilot drill vertically through the shank of the outer handle and bottom latch.

Drill out the lower hole in the outer handle and bottom latch to 3/16" and install the flange nut.

Drill the top hole to #28, install the button head screw and tighten. See **FIGURE 06-10**.

Check entire assembly for function.

S7-S SPINNER ASSEMBLY AND INSTALLATION

(REFER TO PARTS PAGE # 006-10 FOR PARTS SELECTION)

ASSEMBLY

Refer to **FIGURE 06-11/ 06-12**

The spinner and backing plate supplied have been trimmed at the factory and should not require any additional trimming.

Check that the prop extension fits in the predrilled holes of the spinner backing plate. The fit should be tight. Should some sanding be required, use sandpaper around a stick.

Bolt the prop to the backing plate. Sit the spinner dome on top of the prop and determine the locations of the cut outs for the prop blades. See **FIGURE 06-11**.

Using the full size template from **FIGURE 06-11** mark and cut out the openings. **NOTE:** Cut the opening slightly smaller and sand the opening to the exact fit. Cut the openings deep enough to allow the dome to fit over the backing plate so that the edge of the dome sits flush with edge of the backing plate flange. **NOTE:** The spinner dome will not fit over the backing plate until the blade openings have been cut. The clearance between prop and dome should be 1/8" all the way around.

With the openings cut, dimple the spinner dome near one opening and dimple the backing plate corresponding to that opening for alignment markings. Assemble the dome and backing plate each time with the dimples in line.

Cut out and glue together the four full size spinner backing plate templates (**FIGURE 06-12-A to D**). Use the template to mark the hole pattern on the dome as shown.

Drill all holes to #40 with 5/16" edge distance.

With the backing plate and prop sitting on a flat surface, place the spinner dome in position. Press the dome tight to the surface to ensure that the dome and backing plate are flush. Using a #30 drill bit transfer drill through the dome into the backing plate flange. Cleco as you go.

Chase drill using a #11 drill bit and clecos. The dome and backing plate must remain tight against the surface as you drill.

Remove the dome and the prop from the backing plate and install the nut plates. **NOTE:** Counter sink the #40 holes to allow the heads of the rivets to sit flush with the backing plate flange. See **FIGURE 06-11**. "Set" the rivets by resting the head of the rivet against a vise and tapping the driven end with a small hammer. Check for tightness. The nut plates must be snug. The spinner dome and backing plate are now ready to receive their finish.

INSTALLATION

During final assembly install the spacer and the backing plate on the engine prop flange. Install the prop. Refer to **PROPELLER INSTALLATION** and bolt the spinner dome in place.

The spinner and prop should be balanced and no adjustment required. However, the ultimate test is in the running. If you experience a lot of vibration it could be caused by out of balance or misalignment. Use a good prop balancer. Check both the prop and spinner assembly, if the misalignment is not correctable then a new spinner may be required. Misalignment occurs through improper alignment of the parts. A slight amount of "wobble" is acceptable and may disappear at higher RPM's. Always pre-flight your spinner.

S7-S PROPELLER INSTALLATION

(REFER TO PARTS PAGE # 006-12 FOR PARTS SELECTION)

Refer to **FIGURE 06-13 to 06-15**

Install the flange bushings into the prop flange on the engine from the aft side. Use a "C" clamp to completely seat the bushings into the flange. Place a small wood block between the pad of the clamp and the aluminum bushing to protect them from being damaged. Use a piece of tubing approximately 1" long over the flange bushings to allow them to seat as the "C" clamp is tightened. See **FIGURE 06-13**.

Inspect the prop provided for any nicks, crack or dings. The propeller comes from the factory balanced and ready to bolt on, however depending on conditions and how the prop has been stored; it may not be in balance at the time of install. To balance the prop it is best to use a two-axis balancer. These are available from several Aircraft Supply stores. Place the prop on the balancer and follow method to correct balance in **FIGURE 06-14**.

Mount the propeller as per parts drawing using the bolts provided. Note the length of the bolts is critical. Use washers to be certain the bolts are not bottomed out on the threads. **DANGER:** If bolts are bottomed out on the threads, the prop is not properly torque, separation from the aircraft during operation may occur. Torque the bolt from 175 to 200 inch pounds in the pattern shown in **FIGURE 06-14**. Re-torque bolts after 5 hours of flight and thereafter according to manufacturers instructions.

Check prop for tracking by turning blade into a vertical position and placing an object at the tip. Spin the prop to the next blade and check position. If the position is the same the prop is in track. If not, loosen prop bolts and re-torque until proper tracking is achieved. **HINT:** Start torque pattern on the blade that is out of track. See **FIGURE 06-15**. **DANGER:** Track prop with ignition **OFF!!**

Bolt the spinner dome to the backing plate. Refer to the **SPINNER ASSEMBLY AND INSTALLATION** and the spinner section in the parts manual.

S7-S COWLING ASSEMBLY AND INSTALLATION

(REFER TO PARTS PAGE # 006-14, 006-16 FOR PARTS SELECTION)

ASSEMBLY

Refer to **FIGURE 06-16 to 06-20**

IMPORTANT: *The Boot Cowl, Engine, 1" Spacer and Spinner Backing Plate must be installed prior to fitting the cowling. If Firewall Forward was purchased less prop, contact RANS for the proper 1" Spacer.*

NOTE: *It is also recommended to have the entire engine installation completed.*

Temporarily install the propeller spacer and the spinner backing plate to the propeller flange of the engine.

Tape two 3/8" thick wood strips (or similar material) to the aft side of the spinner backing plate as shown in **FIGURE 06-16**.

Clamp or tape the lower cowling in place with the forward side touching the 3/8" spacers. The cowl should fit tight around station 1 and be centered on the spinner backing plate. Check for proper position and alignment.

Mark cut lines; take cowling bottom off and trim closed to the line. **HINT:** *Aviation snips, drum sanders and sanding blocks work well for trimming.* Do not trim all the way to the line. It is better to check fit before final trimming is performed.

Trim the bottom trip lip as per **FIGURE 06-17**.

Trim the prop-opening flange to 1".

Locate and drill the two exit holes for the drain tubes. These holes should be approximate 1/4" larger in diameter than the drain tubes.

Locate and drill a hole for excess to the drain of the gascolator.

Trim the forward side of the top cowling to match the bottom.

With the lower cowling on the fuselage, place the top cowling on the aircraft. It should fit tight over the top of the boot cowl.

Mark and trim the top cowling. Work in steps; do not trim in one step. It is easy to trim too much material off.

Locate and cut the oil door opening. Reference **FIGURE 06-18** and use the cut template in **FIGURE 06-19**. Check fit with parts as per parts manual. Cut opening large enough to allow the oil door to fit even after paint.

Install top and bottom cowls to the aircraft. Center the cowling at spinner backing plate. Cowling must rest firmly against 3/8" spacer. Tape both halves securely together. Check fit. If satisfied mark the bottom and top cowling around the rear edge at the hole locations of the receptacles located at the boot cowl joggle. Use a hole finder or measure back wards along a reference line starting at the center of the hole. Step drill top and bottom cowl at the marked locations to 1/4".

Layout the hole pattern on the top cowl as shown in **FIGURE 06-18** and pre drill to #30.

Install top and bottom cowling. Secure with 1/4 turn studs temporarily to the boot cowl and tape both half's securely together. Transfer drill through the #30 holes in the top cowl into the bottom cowl. Cleco as you go.

Drill out to # 11 and cleco as you go.

Remove both cowlings and cleco the quarter turn receptacles to the bottom cowl. Using a #40 drill bit, drill both mount holes for the receptacles.

Remove the receptacles and drill the quarter turn holes on the bottom cowl out to 5/16". Countersink the #40 rivet holes to allow the rivet heads to sit flush. Install the quarter turn receptacles. Drill the quarter turn holes in the top cowling out to 1/4". See **FIGURE 06-18**.

Test - mount the cowling assembly to the aircraft to assure fit.

Final trim the air inlets in the front of top and bottom cowling. Use the template provided in **FIGURE 06-20** for final sizing. The template should slide through the opening.

Temporarily mount the oil check door assembly to the top cowl. Use clecos to hold the assembly to the cowl and together. Check fit, function and disassemble.

Apply the surface finish to all cowling parts.

INSTALLATION

Refer to **FIGURE 06-18**

Install the oil check door assembly to the top cowling as per parts manual.

Install the 1/4 turn fasteners to the top cowling as per parts manual and **FIGURE 06-18**. **NOTE:** *The length of the 1/4 turn studs depends on the thickness of the fiberglass. Some variation is possible. Therefore three different lengths of studs are provided. Use as required.*

S-7S COVERING

GENERAL INFORMATION

Read this entire section before starting to cover.

The following additional supplies will be required to cover the S-7S.

- Pinking Shears
- Regular Scissors
- Razor Blades
- Covering Irons
- Covering Thermometer
- 2" Brushes
- Containers for Glue and Solvents with lids
- Saw Horses or "A" frame pivot stands
- Methyl Ethyl Ketone (MEK)
- 1/4" double-stick tape

Buy a pair of rotary pinking shears. They will be used to cut all the patches and tapes. The rotary style is so much better than the normal scissors type "pinkers". It is money very well spent.

Neatness and cleanliness during the covering process will reflect in the finished product. **CAUTION:** *Adequate ventilation is necessary.* You may want to obtain the SuperFlite aircraft covering manual from SuperFlite before proceeding.

Before shrinking any fabric, calibrate your covering irons as described. A model airplane iron is also useful in shrinking up tight areas. A regular clothing iron may be used for over all shrinking. The best ones are the old Steel irons. New irons are usually made of Aluminum. They just do not have the mass to work like the old fashion irons. Look for an iron at a garage sale or second hand store, or borrow grannies.

Another problem area is curves. The fabric will want to wrinkle when being glued to a curved corner, like the ones on the tail. The SuperFlite manual points out a slick way to glue down wrinkle free corners. Refer to the manual for basic covering technique.

RANS currently uses SuperFlite U-500 glue, thinned with MEK when required. U-500 will also be used to seal fabric or glue down tapes and patches. References may be made to applying a coat of glue over the entire surface. In general, we do not recommend this, since it prevents adhesion of the base primer coat. Double coating is normally only required in areas of tapes, patches, or underlying sheet metal surfaces. This coating will prevent pinholes.

Thick & Thinned glue is referred to and is normally in the following approximate ratios.

Thick = 3 parts glue : 1 part MEK

Thinned = 1 part glue : 3 parts MEK

Throughout this section, we will be referring to “sizing material”. Sizing material is U-500 adhesive thinned to water like consistency. Keep a container of sizing material handy and apply it to the fabric wherever a cut is to be made. Allow the sizing material to dry before making the cut. This will keep the fabric from fraying and aid in cutting straight.

Patches will have to be applied on top of the fabric as reinforcement or on top of Lexan Reinforcement Rings for exits, Inspection Plates, or drainage holes. The outline of the patches will still be visible after painting. If you want it to look good, then here is how to do it. Use a straight edge or a round template and a soft pencil to mark the outline of the patch on the fabric. Use sizing material and a soft brush to size along the cut line. Let dry and cut the patch out using a pinking sheers. Wherever a cut must be made inside the patch, size and than cut using a razor blade. **NOTE:** *Most cuts inside Inspection Rings, Exits and drainage holes may be done after painting.*

To gain experience, cover a Tail Surface first.

IMPORTANT: *However, cut 4 lengths of fabric 6” longer than the Wings. This will assure enough material for the Wings.*

Most all of the covering techniques are used in the tail. The experience gained will greatly enhance the rest of the job. There is enough fabric for at least one mistake. So, if a tail feather is not right, try again. Work toward perfection and neatness. Take your time; a good job is easy to live with. A bad job...you will spend more time making excuses than it would have taken to do right!

COVER / PAINT STANDS

Cover / Paint Stands may be fabricated from the plans provided in the **FIGURES MANUAL**. Refer to **PARTS MANUAL** for assembly and required hardware. Below is a list of the provided drawings.

| | |
|--------|---------------------------------------|
| KP-100 | A-FRAME STAND |
| KP-103 | WING ROOT ATTACH |
| KP-107 | "T" LOCK HANDLE |
| KP-108 | PAINT STAND FOR FLAPS / AILERONS |
| KP-109 | PAINT STAND FOR HORIZONTAL STABILIZER |
| KP-111 | FWD FUSELAGE ATTACH |
| KP-112 | AFT FUSELAGE ATTACH |
| KP-117 | WING TIP PIVOT |
| KP-118 | AILERON ATTACH |
| KP-119 | ELEVATOR ROOT ATTACH |
| KP-120 | ELEVATOR OUTER ATTACH |
| KP-121 | UPPER RUDDER SUPPORT TUBE |
| KP-121 | LOWER RUDDER SUPPORT |

WINGS

1. Clean the entire frame thoroughly. Blow out all Ribs and Wing Spars to remove metal shavings.
2. Scotch-Brite all sheet metal surfaces and clean with Acetone.
3. Cut out the 2 formed Bolt Covers to lay flat against the Leading Edge Spar and to cover the 3 FWD Strut Attach Plate Bolts. Glue on Bolt Covers.
4. Apply anti-chafe tape around sharp edges (masking tape). Refer to **FIGURE 07A-04**.
5. Apply one coat of thinned U-500 to the sheet metal using a soft wide brush, let dry. The thinned U-500 applied to the metal under surfaces helps prevent pin-holing in the paint finish. Make sure to remove brush hairs from the surface if necessary.
6. Perform pre-covering check using the following items.
 - Assembly completed as per parts manual
 - Aileron cables installed
 - Flap Teleflex Cable installed
 - Fuel and drain lines installed
 - Fuel system leak tested
 - Pitot and static lines installed (left wing only)
 - All nut plates for hinges installed
 - Door Upcatch Socket installed
 - Jury strut attach bracket installed
 - Strobe wiring installed (optional)
 - Anti-chafe tape installed around sharp edges of sheet metal
 - Anti-chafe (Longeron Fairing material) installed to Drag Brace
 - Bolt cover glued over the 3 FWD Strut Attach Plate Bolts

7. Position the Wing top side up on sawhorses or other suitable work surface. **HINT:** *RANS uses two "A" frame stands with pivots so the Wing can rotate and be locked in any position.* You may consider purchasing or building such a device. Contact the factory for information. If you are using such a stand, it is acceptable to drill a 1/4" diameter hole through the Tip Bow for a pivot pin.
8. With the Wing topside up and level, roll out and cut the top layer of fabric so that it extends approximately 3" on each end of the Wing. Pull as much of the fabric to the Trailing Edge of the Wing as possible leaving enough fabric on the Leading Edge to wrap around the Spar.
9. Trim off the excess fabric leaving enough fabric to wrap around the Trailing Edge Spar. Save these scraps, they will be used to cover smaller parts.
10. Refer to the SuperFlite covering manual and mix up a quantity of adhesive.
11. Bond the fabric along the AFT side of the Trailing Edge Spar (about 1 1/2" bonding area is enough at this time).
12. Bond the fabric to the forward face of the Leading Edge Spar (about 2" wide at this time). Pull light tension into the fabric as you go.
13. Bond the fabric around the Tip Bow and the upper Root Rib, pulling in light tension.
14. Iron the surface only enough to take out large wrinkles. You do **NOT** want tension at this time.
15. Glue down the fabric on top of the Fuel Tank Cover (sheet metal) and the Leading Edge Wrap (sheet metal). Apply thin glue with a brush through the fabric surface.
16. Turn the wing bottom side is up.
17. Mark the trim line along the fabric perimeter with a soft pencil, size with thin glue along the trim line and cut using a sharp scissor. Refer to **FIGURE 07A-17** and **07A-17A**.
18. Glue down the extending fabric around the Leading Edge, Trailing Edge, Tip Bow, and Root Rib.
19. Iron out any wrinkles or puckers in the bond area and iron down all edges.
20. Iron the top side to pre-tension the fabric. **CAUTION:** *Do not bring the top skin to final tension until the bottom skin has been pre-tensioned.*
21. With the top fabric pre-tensioned, position the wing bottom side up.
22. Roll out and cut the bottom layer of fabric.
23. Following the same procedure as before; bond the bottom fabric to the Wing Frame and pre-tension. Refer back to **FIGURE 07A-17** and **07A-17A** for trimming the lower fabric.

24. Size and cut the fabric around the Lift Strut Attach Plates, and Jury Strut Bracket.
25. Thoroughly iron the entire Wing surface to final tension the top and bottom fabric.
26. The fabric will need to be riveted under reinforcement Cover Straps to the center of each rib. Refer to **FIGURES 07A-26** thru **07A-26C** for details about riveting. **NOTE:** *The top Cover Straps stop at the backside of the Leading Edge Skin. The bottom Cover Straps extend the full length.*
27. The Cover Straps should extend a minimum of 1/4" past the first and last rivet. Cut the supplied Cover Straps to length and remove the protective plastic covering.
28. Apply small clear double-stick tape on top of the fabric centered along the holes in each rib and extending 1/4" past the first and last hole. Remove the protective paper on top of the double-stick tape and glue on the Cover Strap. Make sure the Cover Strap is centered over the holes in the ribs.
29. Use a hot knife with a pointed tip or a soldering iron and melt through the Cover Strap and the fabric into the Rib holes.
30. Cut the melted build up on top of the Cover Straps off using a razor blade.
31. Insert a Rivet in each hole and rivet.
32. Scuff up the surface of the 2 Strut Attach Plate Exits and the Jury Strut Bracket Exit per wing and glue over the corresponding parts.
33. Layout and mark the Inspection Rings, Flap Teleflex Exit, Aileron Hinge Exit Rings, and Aileron Push-Pull Tube Exit locations as shown in **FIGURES 07A-33** and **07A-33A**.
34. Bond the Inspection and Exit Rings to the fabric in there respective locations.
35. Glue on the 2 drain grommets as per **FIGURE 07A-33**.
36. Using a pinking shear cut out fabric patches as per **FIGURE 07A-33** and glue over the top of the corresponding parts.

37. Cut to length and glue the 2" and 4" surface tape in place. Refer to **FIGURES 07A-33 and 07A-37** and the following text.
- TOP RIBS - 2" tape - centered on each Rib starting flush with the AFT edge of the Leading Edge Wrap and ending on AFT centerline of the Trailing Edge Spar.
 - BOTTOM RIBS - 2" tape - centered on each Rib starting at the FWD centerline of the Leading Edge Spar and ending on AFT centerline of the Trailing Edge Spar, flush with the top Rib Tape.
 - LEADING EDGE WRAP - 2" tape - glue span-wise from Root Rib to Tip Rib centered on the AFT edge of the Leading Edge Wrap.
 - TOP & BOTTOM ROOT RIB - 2" tape - centered on Rib, wrapping around to the interior side starting at the FWD centerline of the Leading Edge Spar and ending on AFT centerline of the Trailing Edge Spar.
 - TOP & BOTTOM TIP RIB - 2" tape - centered on Rib starting at FWD centerline of Tip Bow and ending on AFT centerline of the Tip Bow.
 - TRAILING EDGE SPAR & TIP BOW - 2" tape - centered on AFT centerline of the Trailing Edge Spar, over lapping the lower fabric seam by 1/4", starting flush with the root end of the Spar and ending at the Tip Wrap on the FWD edge of the Tip Bow.
 - LEADING EDGE SPAR - 4" tape - centered on the FWD centerline of the Leading Edge Spar, starting flush with the root end and ending by tapering the tape down to 2" through the Tip Wrap flush with the 2" Tip Bow tape.
38. Use an iron to shrink out any wrinkles or puckers in the surface tape and patches. **IMPORTANT:** *Do not apply heat to the full width of the tape as tape distortion will occur.* Heat the edges or the center allowing one to cool before heating the other. Use the iron to smooth and bond all pinked edges on the tape and patches.
39. Coat all surface tape and patches with thinned U-500 adhesive, concentrating on dry spots and flowing the glue into the pinked edges. **IMPORTANT:** *Do NOT apply glue beyond the pinked edges. The edge of the glue will be seen after painting.*

AILERONS AND FLAPS

1. Use a light hammer and form AFT ends of ribs to follow contour of trailing edge spar.
2. Clean the entire frame thoroughly with Acetone or similar.
3. Apply anti chafe tape around sharp edges of ribs (masking tape) as shown in **FIGURE 07B-03**.
4. Perform pre-covering check using the following items.
 - Nut plates for hinge points (Flap) installed.
 - Anti-Chafe tape applied around sharp edges of ribs.
5. Cut fabric large enough to fit frames as shown in **FIGURE 07B-05**.
6. **NOTE:** *The fabric is glued around the Leading Edge Spar, wrapped around the Trailing Edge Spar and then glued to the Leading Edge Spar.*
7. The fabric should extend past both ends of frames about 2".
8. Glue fabric to Leading Edge Spars, (cut out to clear ribs) let dry and iron edges down.
9. Wrap around Trailing Edge and glue to Leading Edge. Refer to **FIGURE 07B-05**.
10. Cut and glue fabric around both ends of frames (overlap fabric).
11. Let dry and final iron entire surface for tightening of fabric.
12. Apply Drain Grommets (to the bottom side), patches, and tapes (in this order).
13. Refer to **FIGURE 07B-13** for Ailerons.
14. Refer to **FIGURE 07B-14** for Flaps.
15. Iron along tapes and iron down tape edges.
16. The Ailerons and Flaps are now ready for primer and paint.

4. Position the fuselage bottom side up.
5. Roll out and cut a piece of fabric long enough to cover the bottom of the fuselage. Slide the fabric to one side of the fuselage and trim off the excess material. Leave approximately 5" of material on all sides.
6. Secure the fabric to the longerons using cloth pins.
7. Bond one side of fabric to the bottom longeron from station 2 to station 8. **IMPORTANT:** *Apply adhesive to the longeron in the bond area only to prevent dips or puckers in the fabric. See **FIGURE 07C-07**.*
8. Bond the opposite side to the bottom longeron.
9. Bond the fabric at station 2 around the bottom cross tube.
10. Wrap and glue all fabric to the interior side of the fuselage and trim. See **FIGURE 07C-07**.
11. Let dry and iron out all wrinkles and puckers along the bond area. Pre-iron the surface only enough to take wrinkles out.
12. Position the fuselage so the left side is up. **IMPORTANT:** *Do **NOT** cover right side first, it will make trimming excess fabric off the battery door opening harder to do!*
13. Roll out and cut the fabric to length. The fabric panel has to cover the entire left side from the bottom to the vertical stabilizer former (top center of fuselage) including the left side of the vertical stabilizer. Trim off the excess fabric.
14. Bond the fabric to the bottom Longeron. Trim the fabric as shown in **FIGURE 07C-07**. Cover over the battery access door opening. Special instructions will follow on how to finish this area.
15. Bond the remaining perimeter of the fabric around the forward fuselage tubes, the vertical stabilizer former, the vertical stabilizer - leading edge, - top and - trailing edge spar.
16. Trim excess fabric off.
17. Let dry and iron out all wrinkles in the bond area.
18. Cut the fabric in the battery access door as shown in **FIGURE 07C-18** and glue flaps to edges of the door opening.
19. Pre-tension the fabric, only enough to remove bagginess.
20. **CAUTION:** *Use care when pre-tensioning, it is possible to pull the vertical stabilizer and top stringer out of alignment.*
21. Rotate the fuselage to the opposite side and cover following the same procedure. When covering the second side of the fuselage it will be necessary to use a 1-1/2" flat lap joint along the vertical stabilizer stringer from station 3 to station 7.

HORIZONTAL STABILIZER

1. Clean the entire frame thoroughly.
2. Add anti-chafe tape (masking tape) around sharp edges of ribs similar to flaps and ailerons.
3. Perform pre-covering check using the following items.
 - Stabilizer frame is primed.
 - Ribs installed
 - Anti-chafe tape applied to sharp edges of ribs

NOTE: *Both sides of the horizontal stabilizers are covered with a separate piece of fabric.*

4. Cut fabric large enough to fit the frame and with enough excess to allow gluing all the way around the frame tubes.
5. It does not matter which side you apply first. **NOTE:** *It is recommended to apply the fabric to the bottom side first. That will make a smoother finish on the topside.*
6. Glue fabric (first side) all the way around the frame tubes well past the centerline of the tubes as shown in **FIGURE 07D-06**. You have to cut the fabric in the corners, around the stabilizer- attach bushings.
7. Let dry and iron all fabric edges down.
8. Pre-iron the fabric surface only enough to take wrinkles out.
9. Glue fabric (second side) all the way around the frame tubes and past the centerline as shown in **FIGURE 07D-06**.
10. Let dry and pre-iron the surface only enough to take wrinkles out.
11. Let dry and final iron entire surface for tightening of fabric.
12. The fabric will also need to be riveted under the reinforcement Lexan strip to the center of each rib. Refer to **WING COVERING FIGURES 07A-26A to 07A-26C** for details about riveting.
13. The Lexan straps should extend a minimum of 1/4" past the first and last rivet. Cut the supplied Lexan straps to length. Apply the small clear double stick tape on top of the fabric centered along each rib and extending 1/4" past the first and last hole. Remove the protective paper on top of the double stick tape and glue on the Lexan strap. Make sure the strap is centered over the holes in the ribs.

14. Use a hot knife with a pointed tip or a soldering iron and melt through the cover strap and the fabric into the rib holes.
15. Cut the melted build up on top of the Lexan straps off using a razor blade.
16. Insert a rivet in each hole and rivet.
17. Apply drain grommets (to the bottom side), patches, and tapes (in this order).
18. Refer to **FIGURE 07D-18**. **NOTE:** *Only the right horizontal stabilizer receives a seaplane grommet on the bottom side. The opening must face AFT. The trim wiring will exit there.*
19. Iron along tapes and iron down tape edges.
20. The Horizontal stabilizers are now ready for primer and paint.

RUDDER

1. Clean the entire frame thoroughly.
2. Perform pre-covering check using the following items.
 - Hinge stop collars set and riveted.
 - Rudder frame primed.

NOTE: *Both sides of the rudder are covered with a separate piece of fabric.*

3. Cut fabric large enough to fit the frame and with enough excess to allow gluing around the frame tubes all the way around.
4. It does not matter which side you apply first.
5. Glue fabric (first side) all the way around the frame tubes well past the centerline of the tubes. Refer back to **FIGURE 07D-06**. You have to cut the fabric in the corners and around the moving part of the hinge.
6. Let dry and iron all fabric edges down.
7. Pre-iron the fabric surface only enough to take wrinkles out.
8. Glue fabric (second side) all the way around the frame tubes and past the centerline as shown in **FIGURE 07D-06**.
9. Let dry and pre-iron the surface only enough to take wrinkles out. Let dry and final iron entire surface for tightening of fabric.
10. Modify Rudder / Elevator Hinge Reinforcement per **FIGURE 07E-10**.
11. The rudder uses a small piece of .020 Lexan as reinforcement on the bottom forward end on both sides. Fabricate 2 from raw stock according to **FIGURE 07E-11**. Glue reinforcements on.
12. The fabric will also need to be stitched with a single stitch to the center of each rib. Refer to **FIGURES 07E-12** for details about stitching.
13. Apply reinforcements, patches, and tapes (in this order). Refer to **FIGURES 07E-12** and **07E-12A**.
14. Iron along tapes and iron down tape edges.
15. The rudder is now ready for primer and paint.

ELEVATOR

1. Clean the entire frame thoroughly.
2. Perform pre-covering check using the following items.
 - Hinge stop collars set and riveted.
 - Balance weight mount holes drilled and tapped
 - Elevator frames primed
 - Second control horn holes drilled
 - Nut plates for control horns attached

NOTE: *Both sides of the elevators are covered with a separate piece of fabric.*

3. Cut fabric large enough to fit the frame and with enough excess to allow gluing around the frame tubes all the way around.
4. It does not matter which side you apply first. **NOTE:** *It is recommended to apply the fabric to the bottom side first. That will make a smoother finish on the topside.*
5. Glue fabric (first side) all the way around the frame tubes well past the centerline of the tubes. Refer back to **FIGURE 07D-06**. You have to cut the fabric in the corners, around the moving part of the hinge and the trim tab attach.
6. Let dry and iron all fabric edges down.
7. Pre-iron the fabric surface only enough to take wrinkles out.
8. Glue fabric (second side) all the way around the frame tubes and past the centerline as shown in **FIGURE 07D-06**.
9. Let dry and pre-iron the surface only enough to take wrinkles out.
10. Let dry and final iron entire surface for tightening of fabric.
11. The fabric will also need to be stitched with a single stitch to the center of each rib. Refer to **FIGURE 07E-12A** for details about stitching.
12. **NOTE:** *On the right elevator inboard stitch only, the top surface is stitched to the frame (the trim exit ring goes on the bottom side).*
13. Glue drain grommet to the bottom inboard side of each elevator.
14. Scuff surface of trim exit ring and glue on as per **FIGURE 07F-14** on bottom side of right elevator.
15. Apply reinforcements, patches and tapes, in this order, as per **FIGURE 07F-14**.

DOORS

1. Clean the entire frame thoroughly.
2. Perform pre-covering check using the following items.
 - Door frames primed

NOTE: *Both sides of the lower doorframes are covered with a separate piece of fabric.*

3. Cut fabric large enough to fit the frame and with enough excess to allow gluing around the frame tubes all the way around.
4. It does not matter which side you apply first. **NOTE:** *It is recommended to apply the fabric to the inside first. That will make a smoother finish on the outside.*
5. Glue fabric (first side) all the way around the frame tubes. The fabric should be glued to 3 sides of the square frame tubes. You have to cut the fabric in the corners.
6. Let dry and iron all fabric edges down.
7. Pre-iron the fabric surface only enough to take wrinkles out.
8. Glue fabric (second side) all the way around the frame tubes. Again, it is recommended to glue the fabric to 3 sides of the square frame tubes.
9. Let dry and pre-iron the surface only enough to take wrinkles out.
10. Let dry and final iron entire surface for tightening of fabric.
11. Patch and tape in order as per **FIGURE 07G-11**.
12. Iron along tapes and iron down tape edges.
13. The doors are now ready for primer and paint.

S-7S BAGGAGE COMPARTMENT ASSEMBLY AND INSTALLATION

ASSEMBLY

(BEFORE COVERING OF FUSELAGE)

IMPORTANT: *The baggage compartment must be fit-up before the fuselage is covered.*

1. Tape all sheet metal parts of the Baggage Compartment together. Refer to parts page drawing for proper orientation in relationship to the flanges. **HINT:** *When assembled, flanges will **NOT** be visible from the inside of the Baggage Compartment.*
2. Transfer drill #30 the 3 lower aft corner pre-located holes on each side and cleco. **NOTE:** *1 hole per part per corner will be transfer drilled and clecoed.*
3. Slide taped assembly into place. The Back will rest against the tabs welded to Station 4. The forward end of the Bottom will be on top of the tabs at Station 3.
4. Adjust the assembly up or down at each side until the Sides lap about half way onto the fuselage tube. Tape in place.
5. Press the forward end of the Sides against the tabs on Station 3 and tape in place. Adjust as needed.
6. Make sure the assembly is tight against all tabs. Transfer drill #11 through tabs. Cleco as you drill.
7. Transfer drill #30 though flanges of Baggage Compartment. Cleco as you drill.
8. Cut Support Angles to length. Refer to **FIGURE 08-08** and **FIGURE 08-08A**. Trim ends to clear fuselage tubes, Support Angle and welded tabs as indicated. Mark Support Angles for hole placement. Orientate, transfer drill through tabs #11 and cleco. Drill angles #30 and cleco.
9. Rivet all flanged areas together.
10. Rivet Support Angles to Baggage Compartment sheet metal.
11. Remove Baggage Compartment. Install nut plates to all large tabs on fuselage. Refer to parts manual.

BAGGAGE COMPARTMENT INSTALLATION

INSTALLATION

(AFTER COVERING AND PAINTING OF FUSELAGE)

12. Cover interior of Baggage Compartment with lightweight fabric or paint as desired.
13. If covered in fabric, burn through mounting holes with a hot knife or soldering iron.
14. Slip Baggage Compartment into fuselage. Retain with Machine Screws.

CARGO NET

15. Cargo Net will be retained by upper aft and fwd outer machine screws retaining Baggage Compartment. Secure through metal grommet at end of each strap. Refer to parts pages.

S-7S SEAT ASSEMBLY AND INSTALLATION

ASSEMBLY

1. Using a #40 bit, drill through the center of the PVC inserts. Install the inserts into the Seat Tensioning Rib flush with the end of the Rib.
2. Using a center punch, dimple the Rib near the end to secure the inserts. See **FIGURE 08A-02**.
3. Install the Seat Tensioning Rib into the Tensioning Bracket using the screws shown in the parts drawing.
4. Drill the side tubes of the Seat Tensioning Bracket as shown in **FIGURE 08A-04**.
5. Cleco the Seat Corner Brace to the Tensioning Bracket and using the Corner Brace as a guide, mark the second hole location onto the Tensioning Bracket. Remove the Corner Brace and drill the second hole.
6. Slip the Tensioning Bracket onto the lower legs of the Seat Side Frames. Note the orientation of the Tensioning Bracket. Refer to the parts drawing.
7. Install the Seat Top Tubes into the Side Frames as shown in the parts drawing. **NOTE:** *The Seat Back Cushion will retain the Top Tube.* Position the Seat Tensioning Bracket as shown in **FIGURE 08A-07**.
8. Transfer drill through the pre-drilled holes in the Tensioning Bracket into the Side Frames.
9. Rivet the Seat Corner Brace to the Tensioning Bracket and Side Tubes. Using the Corner Brace as a guide, transfer drill through the upper aft holes into the Seat Back Side Frame and rivet.
10. Mark the centerline of the upper forward sides and top of the Seat Frame. Refer to **FIGURE 08-10**. Position the Seat Back Plate as shown. **NOTE:** *If desired, the top and side edges of the plate may also be flanged with a rolling-flange tool to contour to the seat frame. Drill and rivet in place.*
11. With the Seat Assembly, bottom side up, mark the bottom centerline on the Side Tubes. **HINT:** *Pull a straight edge along the bottom of both tubes to mark a centerline on the tubes.* Refer back to **FIGURE 08A-07**.

12. Tape a straight edge to the forward side of the Seat as shown in **FIGURE 08A-07**. Position the Seat Attach Channels on centerline of each Bottom Tube, touching the straight edge and transfer drill through the Channels into the Seat Frame. **NOTE:** *It is important to locate the Channels on the centerline to ensure that the Seats slide freely.* Cleco the Channels only at this time. The Bottom Seat Cover must be installed prior to riveting the Channels in place.
13. Cut to length and insert the stainless steel wires into the pockets in the Seat Covers.
14. Bend a hook on each end of the wire to retain in position. See **FIGURE 08A-14**.
15. Lay out and mark the hole pattern as shown in **FIGURE 08A-14**.
16. Using a hot knife or soldering iron, melt a small hole at each location just above the wire.
17. Remove the Seat Attach Channels and slip the covers onto the Seat Frames.
18. Thread the Seat Cover tongues between the Seat Tensioning Rib and the Seat Tensioning Bracket. Insert the zip ties and tension evenly. When tensioning the Bottom Cover, tension the aft (longitudinal) ties first and then the side to side ties.
19. With the Seat Covers properly tensioned, melt through the Seat Attach Channel mount holes and rivet the Channels in place.

CAUTION: Use only Stainless Steel Rivets to fasten
Seat Attach Channels to Seat Frame!

INSTALLATION

20. Install the Seats into the Fuselage using the Quick Pins. The ears on the Spreader Tube extend down the outboard side of each rail. Slide the Seat through its full range of adjustment. Determine and mark the wear area on the Fuselage Seat Rails. Refer to the parts manual. Remove the Seats and install wear-tape in this area.

S-7S SEAT BELT ASSEMBLY AND INSTALLATION

(REFER TO PARTS PAGE # 008-06 FOR PARTS SELECTION)

(AFTER PRIMING OF FUSELAGE FRAME/ BEFORE COVERING)

Prior to covering drill the fuselage lap belt mount tabs out to $\frac{1}{4}$ ". Refer to the parts drawing for the mount tab locations. Install the aft shoulder belt mount bolt into the bushing and temporarily finger tighten the nut onto the bolt. **IMPORTANT:** This bolt must be in place prior to covering.

(AFTER COVERING AND PAINT OF FUSELAGE)

After the fuselage has been covered and painted, bolt each belt to the respective mount as shown in the parts drawing. **NOTE:** *Drill the 3/16" Large Washer to 5/16".*

Use the elastic bands on the lap belts and lower shoulder belts to hold the tail of the belts after adjustment has been made.

S-7S RUDDER CABLE GUARD INSTALLATION

(REFER TO PARTS PAGE # 008-08 FOR PARTS SELECTION)

Locate, drill and rivet Support Tube to Rudder Cable Guard, approximately 1½" AFT of front edge (front is curved edge). Secure with at least 4 rivets.

Locate screw holes along guard edges in 3 places.

Center guard over the Rudder Cables, parallel to edge of floorboard and evenly overlapping side to side.

Remove Rudder Cable Guard Assembly and cover with provided Rudder Cable Guard Fabric. *HINT: 3M brand General Trim Adhesive works well.*

To install, use #8 Pan Head Screws and self-tap into floorboard.

S-7S STATION 3 CLOSE OUT INSTALLATION

The Station 3 Close Out is a thermal formed plastic cover. Some trimming is required before installation.

1. Modify Hold Down Strip per **FIGURE 08D-01**. Slide Hold Strip between welded fuselage tabs and Baggage Compartment Bottom. Locate and drill #11 holes.
2. Hold Down Strip may be bent by clamping under a 2x4 block to edge of table. About half of width should hang over edge of table. Use a board and press down on overhang until proper bend is acquired. Refer back to **FIGURE 08D-01**.
3. Follow the molded in trim lines and check fit frequently. Refer to the parts drawing for general configuration.
4. Provide sufficient clearance for the Rudder Cables and the Control Stick Torque Tube.
5. Mark and drill four 1/4" holes at the lower mount tang and the upper mount bracket locations. Close Out will attach with supplied screw rivets. **HINT:** *It may be easier to locate lower mount holes without Baggage Compartment in place.*
6. Check that the Close Out does not interfere with any of the control system elements. **NOTE:** *You may want to attach the vertical portion of the Close Out to the fuselage, after painting, with self-adhesive Velcro. Velcro will allow easier access for inspections than double stick tape.* Lower edge of Close Out may also be trimmed to allow clearance for Fuel Lines, antenna cables, and electrical lines as needed.
7. Hold Down Strip serves to hold Close Out against Baggage Compartment Bottom and should be installed after Close Out is attached.

S-7S THROTTLE CABLE COVER INSTALLATION

1. The throttle cable cover is made from thermal formed plastic. Some trimming is required before installation.
2. Follow the molded in trim lines and check fit. Refer to the parts drawing for general configuration.
3. Locate the 3 small dimples in the cover and drill #11. Two will be used for mounting to the welded stubs. The dimple in the large recessed area will be for the Friction Knob. Slightly slotting the mounting holes for better fit is acceptable.
4. Check that the cover is not interfering with the Throttle Lever, Link Tube, or Throttle Cables.
5. Insert Friction Knob with washers and spacer.
6. Install socket head cap screws with a small amount of Loctite.
7. Final check for interference.

S-7S ELEVATOR MASS BALANCE

The **ELEVATORS** must be a 100% static mass balanced in reference to the surface hinge line.

Balance each surface separately, before mounting to the airplane.

At the time of balancing the surface and attachments must be completely assembled and painted (ready for mounting).

Balance is achieved through the attachment of external Lead weights.

NOTE: Lead sheet is **NOT** provided in the kit.

CAUTION: Wear rubber gloves and a particle mask when working with Lead. Lead is a heavy metal and is dangerous for your health. Take care when working with Lead to clean up all shavings and to store Lead products out of reach of children.

ELEVATORS

(AFTER PAINT AND ASSEMBLY AND BEFORE MOUNTING)

1. The Elevator must be completely assembled and painted.
2. The Elevator Horns, Trim Servo including push rod, wires, Trim Tab, and Trim Exit Cover with screws must be installed.
3. Refer to **FIGURE 09-03**. Use a flat and level surface and two angles. Lay the elevator on the angles as shown. The “sharp edge” of the angle should be up.
4. Obtain 1/4” Lead plate and fabricate three weights as shown in **FIGURE 09-04**. **Note:** The weights will need modification later to achieve final balance. The right Elevator will require more weight than the left because of the Trim Servo. **NOTE:** Thinner Lead Plate may also be used, but will require more layers.
5. Bolt the weight in place and check the balance. Modify the weight by cutting it down until level balance is achieved.
6. Final attach weight.
7. Repeat for other Elevator.
8. Install Elevator. Refer to **HORIZONTAL STABILIZER AND ELEVATOR ASSEMBLY AND INSTALLATION**.

S-7S WINGS

WING WASHOUT RIGGING

(AFTER WING INSTALLATION)

NOTE: Washout is set after the Wings and Struts are installed.

Washout is set by adjusting the lower rear strut fitting (rod end).

A Digital Level can simplify rigging procedures.

CAUTION: The Rod End must be screwed into the strut fitting a **minimum of 10 complete turns.**

1. Fabricate a rigging level as per **FIGURE 09A-01**. Use a straight board or angle (a straight 2x4 will work). Fabricate three 1/4" thick shims as shown and attach two 1/4" thick shims to the rigging level.
2. Air up the tires to high pressure and set the brakes, or better yet remove main wheels and place axles on wooden blocks. The aircraft must be rigid.
3. Raise the Tail of the airplane by placing the Tail Wheel on a sawhorse or other support until the **wing root** is level. Use the fabricated level placed with the 1/4" shims on the bottom of the leading and trailing edge spar to measure. Adjust the tail height until level reading.
4. Do not move aircraft.
5. Tape an additional 1/4" shim to the level as shown in **FIGURE 09A-01**. Place level just outboard of the Lift Strut Attach Plates with the two 1/4" shims under the trailing edge spar. Adjust Rod End in lower end of AFT Lift Strut until level reading is obtained. **CAUTION:** *The Rod End must be screwed into the strut fitting a minimum of 10 complete turns.*
6. Repeat for the other side. **NOTE:** Only one wing root is used as reference. Do **NOT** adjust airplane to level on other wing root.
7. Tighten all connections and check.

AILERON RIGGING

Neutral position and cable tension

(AFTER WING INSTALLATION/ AFTER SETTING OF WASHOUT)

8. Center forward control stick in neutral position (aileron neutral) and securely fix in this position.
9. By adjusting the turnbuckles set the aileron bell cranks to neutral position as shown in **FIGURE 09A-09**. With the stick centered and the bell cranks in neutral position, the cables should be tight.
10. Without a cable tension meter, adjusting the cables will have to be an educated guess. The correct tension does not overload or “drag” the system, nor will cables feel spongy. If you have a cable tension meter refer to **FIGURE 09-07** for tension information.
11. Using the modified wing washout rigging board as shown in **FIGURE 09A-01**. Hold the rigging board so that it is contacting the bottom side of the leading edge spar and the bottom side of the trailing edge spar at approximate aileron half span. The trailing edge of the aileron should rest on the shim (level with lower surface of both spars).
12. With the control sticks and bell cranks neutral install the short aileron push pull tube. **CAUTION:** *Rod Ends must be turned into the push pull tube at least 10 complete turns.*
13. Tighten all connections and check.

Deflections

14. For deflection measurements center control stick for neutral position, move and hold control stick against stop and measure.
15. Measurement is taken on top surface of aileron at approximate half span on top of aileron rib. Deflection angle is in reference to trailing edge of Aileron.
16. Adjust aileron stops as required. Reference also **FIGURE 02-02**. Make sure the Aileron Leading Edge is not contacting the Aileron Hinge.
 - Up: 33° (Tolerance is +2.0° / -1.0°)
 - Down: 30° (Tolerance is +2.0° / -1.0°)

Surface clearance

17. Refer to **FIGURE 05F-04**.
 - The minimum clearance between aileron and wing tip is 0.13”.
 - The minimum clearance between aileron and flap is 0.2”.

Operational check

18. Move the controls in the cockpit throughout the full range of deflection. Check for:
 - Correct deflections of control surfaces.
 - Interference of controls, linkages, cables, surfaces with other components.
 - Excessive friction.

FLAP RIGGING

Neutral position

(AFTER WING INSTALLATION/ AFTER SETTING OF WASHOUT)

19. Place flap handle in flaps retracted position.
20. Using the modified wing washout rigging board as shown in **FIGURE 09A-09**. Hold the rigging board so that it is contacting the bottom side of the leading edge spar and the bottom side of the trailing edge spar at approximate flap half span. The trailing edge of the flap should rest on the shim (level with lower surface of both spars).
21. Adjust the female rod end on the flap cable as required for neutral flap position. **CAUTION:** *Minimum thread engagement is 10 full turns.*

Deflections

22. For deflection measurements move flap lever all the way up (second notch).
23. Measurement is taken on top surface of flap at approximate half span on top of flap rib.
 - Down: 34° (Tolerance is +2.0° / -2.0°)

Surface clearance

24. Refer to **FIGURE 05F-04**
 - The minimum clearance between surface and gap seal is 0.060”.
 - The minimum clearance between flap and aileron is 0.2”.

Operational check

25. Move the flap lever in the cockpit throughout the full range of deflection. Check for:
 - Correct engagement of the roller in the grooves of the flap side plates in each flap lever position.
 - 1/8” minimum clearance of flap lever to seat cross tube with the lever in the up most position. If needed place washers between the U- bracket and the square tube to obtain clearance. Reference **parts page 002-10**.
 - Interference of controls, linkages, cables, surfaces with other components.
 - Excessive friction.

S-7S TAIL SURFACES

TAIL ALIGNMENT AND ROD TENSION

1. Rotating the brace rod in the tie rod ends sets the tail brace rod tension. Rods and rod ends are left and right hand threaded to allow that.
2. The tension in the rods can cause the tail to warp or to get out of alignment.
3. Perform the following checks after the tail brace rods are tensioned.
 - Check alignment of vertical and both horizontal stabilizers in reference to wing carry through (upper member fuselage frame/ forward wing attach). Take measurements at rear spar of horizontal stabilizers and approximate half span. The misalignment should be no more than 0.5° .
 - Check both horizontal stabilizers for twist. Take measurements inboard at root and outboard of tail brace rod attach. Use straight edge across surface. Maximum allowable twist is $\pm 0.5^{\circ}$.
 - Check vertical stabilizer for twist (optical).
 - Adjust rod tension by feel.
 - Check thread engagement of rod in tie rod ends. Rod should penetrate tie rod end past the check hole. Use a piece of wire for checking.

ELEVATOR

Neutral position

4. In neutral position the elevators are level with the horizontal stabilizer. Verify using a straight edge across the surface with a 3/16" shim at the elevator trailing edge.
5. It is possible to adjust at the connection of the elevator horns to the push-pull tube (rod ends). A minimum of 10 full turns thread engagement must be assured.

Deflections

6. Determine neutral position of elevator as reference for deflection measurement. Use a straight edge across horizontal stabilizer and elevator with 3/16" shim at elevator trailing edge for neutral position determination.
7. Move stick in cockpit aft. Hold and measure deflection on elevator at approximate half span. Adjust Forward Pitch Stop, on top of AFT 1-1/2" Push-Pull Tube, to rest against Pitch Stop Tube at Station 6 inside Fuselage, to obtain the listed UP deflection. Repeat with stick at forward position and adjust Pitch Stop for DOWN deflection.
 - UP: 28° (Tolerance is +3.0° / -0.0°)
 - DOWN: 20° (Tolerance is +3.0° / -0.0°)
8. Adjust Pitch Stops as needed until correct Deflections are obtained. Safety Wire between tops of Pitch Stops and over the Pitch Stop Tube. Refer to **FIGURE 09B-08**. The Safety Wire will lessen the potential for the AFT 1-1/2" Push-Pull Tube from deflecting under load and causing the Pitch Stops to jam the Elevators in full deflection.

Surface clearance

8. Refer to **FIGURE 09B-09**
 - The minimum clearance between elevator and horizontal stab. Is 0.060" all the way along the hinge line.
 - The minimum clearance between the elevator horn and the horizontal stab. Tip is 3/16".

Static balance

10. Both elevators must be 100% static balanced in reference to the hinge line.
11. For instructions refer to **CONTROL SURFACE BALANCE**.

Operational check

12. Move the controls in the cockpit throughout the full range of deflection. Check for:
 - Correct deflections of control surfaces.
 - Interference of controls, linkages, surfaces with other components.
 - Excessive friction.

ELEVATOR TRIM TAB

13. The elevator trim tab is operated by servo.

Deflections

14. Measure deflection on top of trim tab at push-rod attach.
 - Up: 30° (Tolerance is +3.0° / -3.0°)
 - Down: 25° (Tolerance is +3.0° / -3.0°)

Surface clearance

- The minimum gap between trim tab and elevator is 0.060" all the way.

Indicator position

16. Verify neutral position of trim position indicator at neutral trim tab.

Operational check

- Correct deflections of trim tab.
- Visual check trim tab for twist.
- Check free movement of trim tab through one full motion and listen for unusual noises from servo.

RUDDER**Neutral position and cable tension**

17. Verify neutral position of rudder with forward rudder pedals neutral (visual).
18. Cable tension should be a minimum of 15 lb measured on both cables under rear seat. Replace Rudder Return Springs as needed.

Deflections

19. For deflection measurements move pedal in cabin, hold at full travel position and measure at rudder. Adjust stops as required.
 - Left: 28° (Tolerance is +3.0° / -0.0°)
 - Right: 28° (Tolerance is +3.0° / -0.0°)

Surface clearance

- The minimum gap between rudder and vertical stabilizer is 0.060" all the way.
- The minimum gap between rudder and top of vertical stabilizer is 1/8".

Operational check

20. Operate forward and rearward rudder pedals throughout full range of travel and check for:
 - Correct rudder deflection.
 - Interference of controls, linkages, cables and rudder with other components.
 - Excessive friction.

S-7S CARBURETOR HEAT

DESCRIPTION OF DESIGN

1. Each one of the two carburetors of the Rotax 912ULS engine has a separate pre-heating system consisting of a heat exchanger, heat control unit and connecting duct hose. One control knob operates both systems.
2. A heat exchanger is mounted to both sides of the exhaust muffler.
3. The instrument panel mounted control knob opens or closes the valves in both heat control units with a simple mixer simultaneously. The position of the valve determines if the engine runs on “cool” air coming through the air filter or on “hot” air coming from the heat exchanger.

ADJUSTMENT

4. Initial and re-adjustment of valve position is possible with cable stops on each unit.
5. The full open and full closed position must be verified during initial installation and later maintenance by removing the air filter and looking in the unit from the top.
6. A spring mounted to each control unit supports the closing of the heat control valve and assures a fully closed valve when carburetor heat “off” is selected and therefore cool air supply and maximum engine performance.
7. Refer to **FIGURE 09C-07** for further details.
8. A cable friction block on the main control cable allows for adjustment of friction to support the “On” position of the heat control knob. Refer to **FIGURE 09-11**.

S-7S CABIN HEAT

1. Check cabin heat valve is full “closed” with control knob in “OFF” position and full “open” with control knob in “ON” position. Adjust by loosening the padded clamp close to the control valve at the muffler wrap and sliding the cable housing up and down in the clamp.
2. Adjust the friction adjustment to provide enough friction on the cable to keep it from moving unintentionally. If satisfactory adjustment cannot be accomplished at cable housing, loosen swivel stop for adjustment at the control arm. Refer to **FIGURE 09D-02** for location of adjustment points.

S-7S PARK BRAKE

3. Check parking brake valve is full open (down) with control knob in “OFF” position and full closed (up) with control knob in “ON” position. **NOTE:** *The parking brake valve works as a “one-way” valve when “ON”.* If this is not the case, adjust by loosening the swivel stop for adjustment at the control arm.
4. Adjust the friction adjustment to provide enough friction on the cable to keep it from moving unintentionally. Refer to **FIGURE 09D-04** for location of adjustment points.

S-7S THROTTLE AND CHOKE

5. Check choke lever is full closed (down) with control knob in “OFF” position and full open (up) with control knob in “ON” position. If this is not the case, adjust by loosening the cable stop for adjustment at the cable guide on the carburetor.
6. Adjust the friction adjustment to provide enough friction on the cable to keep it from moving unintentionally. For the throttles, refer to Maintenance Manual for ROTAX® Engine Type 912 Series. Refer to **FIGURE 09D-06** for location of adjustment points.

S-7S WEIGHT AND BALANCE

INTRODUCTION

This Section describes the procedures for establishing of basic empty weight and moment of the airplane.

Procedures for calculating the weight and moment for various loadings are also provided. Sample forms are provided for reference. Refer to **FIGURES 10-01 AND 10-01A** in the **FIGURES** manual.

Always check your weight and balance during your pre-flight planning. It is recommended to check the data for landing and take off (fuel weight change).

It is the responsibility of the pilot to ensure that the airplane is loaded properly.

AIRPLANE WEIGHING PROCEDURES

1. Preparation:
 - Inflate tires to recommended operating pressure
 - Parking brakes set
 - Drain all fuel
 - Service engine oil as required to obtain a normal indication
 - Move seats to the most aft position
 - Retract flaps
 - Place all control surfaces in neutral position
2. Leveling:
 - Raise tail to level door frame longeron. Refer to **FIGURE 10-01**. (A stand between tail wheel and scale is required).
 - Place scales under each wheel (360 lb. minimum capacity)
3. Weighing:
 - With the airplane level, record the weight shown on each scale and subtract the weight of the leveling device from the weight indicated at the tail wheel.

Use **FIGURE 10-02** to record history and changes in Weight & Balance.

WEIGHT AND BALANCE

The following will enable you to determine the weight and balance of your aircraft and to operate it within the prescribed center of gravity limitations.

The S-7S is a simple aircraft and so are the weight and balance calculations.

The S-7S is limited to two occupants.

For solo flight, the pilot must occupy the front seat.

For baggage storage, a baggage compartment behind the rear seat is available. The compartment is rated for 50 lb. The Cargo Net should be closed securely in flight.

To figure the weight and balance use the Sample Loading Problem and Center of Gravity Envelope as follows:

Enter the following data on the chart. Refer to **FIGURES 10-01** or **10-01A**.

- Weight of Main Gear – Left.
- Weight of Main Gear - Right.
- Weight of Pilot.
- Usable Fuel (at 6 lbs. / gal).
- Weight of Passenger.
- Weight of Baggage (Max 50 pounds).
- Weight of Tailwheel

Calculate the moments (Weight x Arm).

Add moments to obtain total moment.

Add weights to obtain total weight.

Calculate Center of Gravity. (**CG = Total Moment / Total Weight**)

Check that the Center of Gravity calculated for take-off falls inside of the acceptable Center of Gravity limits. Refer to **FIGURE 10-01** or **10-01A**.

Repeat for landing configuration.

S-7S LIMITATIONS

INTRODUCTION

The following operating limitations are necessary for the safe operation of the airplane.

It is recommended to have the engine Operators Manual on board of the airplane.

AIRSPPEED LIMITATIONS

The following airspeed limitations apply.

| | Airspeed | IAS | Remarks |
|----------|---|---------------------------|---|
| V_{NE} | Never Exceed Speed | 135 mph (117 knots) | Do not exceed this speed in any operation |
| V_A | Maneuvering Speed at maximum gross weight | 105 mph * (91 knots *) | Do not make full or abrupt control movements above this speed. |
| V_{FE} | Maximum Flap Extended Speed | 80 mph (70 knots) | Do not exceed this speed with flaps extended. |

* At weights below maximum gross weight, maneuvering speed should be reduced 3 mph for each 50 lb. the aircraft weighs below maximum gross weight.

AIRSPEED INDICATOR MARKINGS

Airspeed indicator markings and their color code meanings are shown in table below.

| Marking | IAS Value or Range | Meaning |
|------------|-----------------------------------|---|
| White Arc | 33 – 80 mph (29 - 70 knots) | Full Flap Operating Range. Lower limit is maximum weight stalling speed in landing configuration. Upper limit is maximum speed permissible with flaps extended. |
| Green Arc | 39 – 105 mph (34 – 91 knots) | Normal Operating Range. Lower limit is maximum weight VS at most forward CG with flaps retracted. Upper limit is maximum structural cruising speed. |
| Yellow Arc | 105 – 135 mph (91 – 117 knots) | Operation must be conducted with caution and in smooth air only. |
| Red Line | 135 mph (117 knots) | Maximum speed for all operations |

WEIGHT LIMITS

| | |
|--|----------|
| Maximum Ramp weight: | 1320 lb. |
| Maximum Takeoff weight: | 1320 lb. |
| Maximum Landing weight: | 1320lb. |
| Maximum weight in Baggage compartment: | 50 lb. |

CENTER OF GRAVITY LIMITS

Forward is 46.1”
Aft is 50.5”

MANEUVER LIMITS

This aircraft is intended for non-acrobatic operations.

FLIGHT LOAD FACTOR LIMITS

| | |
|----------------------|-----------------|
| Flight Load Factors: | |
| Flaps UP: | + 4.0 g, - 2.0g |
| Flaps Down: | + 2.0 g, 0 g |

KINDS OF OPERATION LIMITS

This aircraft is limited to two occupants only.
During solo flights the pilot must sit in the front seat.

FUEL LIMITATIONS

Approved Fuel Grades: Dependent on engine used.

Fuel Capacity:

| | |
|--------------------------------|--------------|
| Total Capacity: | 28.75 US GAL |
| Total Capacity each Wing Tank: | 13.00 US GAL |
| Total Capacity of Header Tank | 2.75 US GAL |
| Total Usable is approximate: | 28.45 US GAL |
| Total Unusable is approximate: | 0.30 US GAL |

► **NOTE:** *Due to cross feeding between fuel tanks, the tanks should be re-topped after each refueling to assure maximum capacity.*

The fuel quantity indicator is calibrated to read correct in horizontal level flight (cruise) only.

The readings given by the fuel quantity indicator in 3-wheel ground attitude are therefore not correct.

The Header Tank does not have a fuel level indicator. When the wing fuel indicator first reads Zero, then approximately 2.45 gallons of fuel remains. The fuel remaining in the header tank after the wing fuel indicator reads zero cannot be safely determined in flight.

S-7S NORMAL PROCEDURES

The following checklists are provided for guidance only. It is suggested that the owner of the aircraft adds items they deem necessary.

PREFLIGHT INSPECTION

Visually inspect the aircraft for its general condition during the walk around. In addition to the items listed on the preflight checklist, look for signs of visible ice if applicable. The presence of ice on the aircraft wings and tail will adversely affect the aircraft's performance. In all cases, remove the ice BEFORE beginning any flight operations. Always exercise due care and good judgment. It is also recommended to remove visible moisture (water) from at least wings and tail surfaces because of its negative effects on performance of the aircraft.

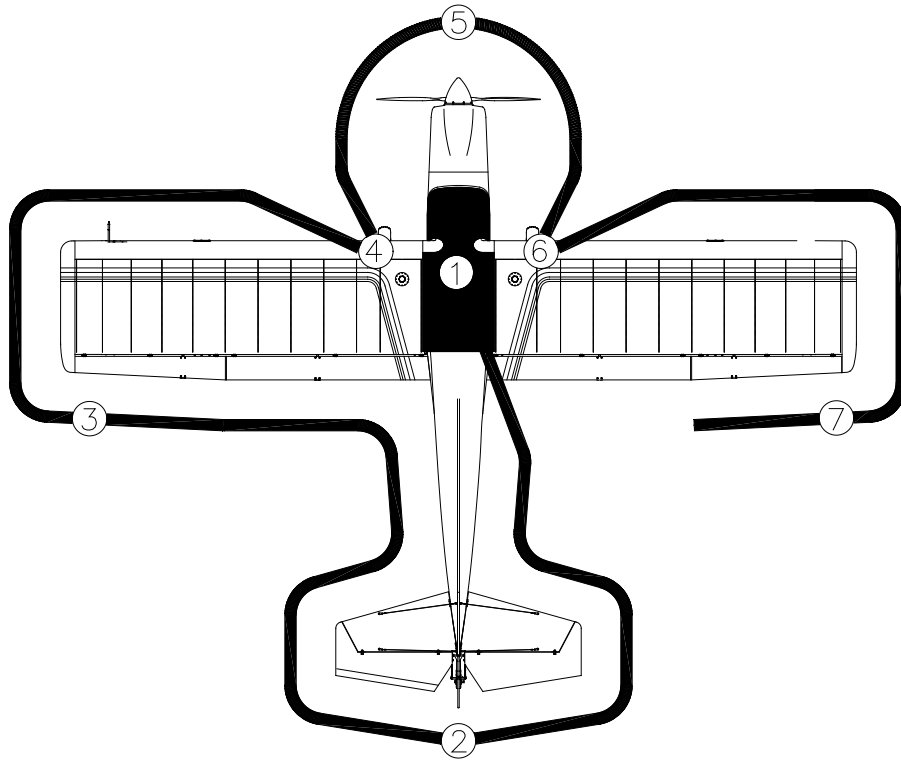

FIGURE 10-08. Preflight Inspection Sequence

The entire outer surface of the AC should be inspected for damage of any kind during the preflight inspection. This is especially important due the fact that the AC is fabric covered.

1 Cabin

- (1) Parking brake – SET
- (2) Ignition switch - OFF
- (3) Master switch - OFF
- (4) Avionics Master - OFF
- (5) Circuit Breakers - CHECK IN
- (6) Fuel Selector Valve – ON
- (7) Fuel Quantity Indicator – CHECK QUANTITY
- (8) Throttle Lever – MOVEMENT - free
- (9) Seats – ADJUST POSTION – CHECK PINS
- (10) Cabin – CHECK FOR FOREIGN ARTICLES
- (11) For Solo flight – SECURE rear seat belts

Check fuselage.

2 Empennage

- (1) Tail brace rods and attach hardware - CHECK
- (2) Horizontal stabilizer and vertical fin - CHECK
- (3) Control surfaces – CHECK freedom of movement and security
- (4) Tail gear and attach, cable and springs – CHECK freedom of movement
- (5) Tail Tie Down – DISCONNECT
- (6) Fabric (Surface) - CHECK - for rips, tears, damage

Check fuselage.

3 Left Wing- Trailing Edge

- (1) Fuel quick drain valve on bottom of fuselage (behind rear seat); - DRAIN at least a cupful of fuel (using sampler cup) to check for water, sediment and proper fuel grade before first flight of day and after each refueling. If water is observed, take further samples until clear, and then gently rock the wings to move any additional contaminants to the sampling points. Take repeated sampling from all points until no contamination is found.
- (2) Flap – CHECK security
- (3) Aileron – CHECK freedom of movement and security
- (4) Rear strut and jury strut attach – CHECK security, dents, nicks
- (5) Fabric (Surface) - CHECK - for rips, tears, damage

4 Left Wing

- (1) Wing tip – CHECK security
- (2) Pitot tube – CHECK security
- (3) Leading edge – CHECK condition, dents, nicks
- (4) Wing Tie Down - DISCONNECT
- (5) Forward lift strut and jury strut - CHECK security, dents, nicks
- (6) Fuel quantity – CHECK visual for desired level
- (7) Fuel filler cap – CHECK secure
- (8) Main wheel tire – CHECK for proper inflation
- (9) Main Wheel – CHECK security, brake
- (10) Fabric(Surface) - CHECK - for rips, tears, damage

5 Nose

- (1) Fuel quick drain valve on bottom of cowling (left side); - DRAIN at least a cupful of fuel (using sampler cup) to check for water, sediment and proper fuel grade before first flight of day and after each refueling. If water is observed, take further samples until clear, and then gently rock the wings to move any additional contaminants to the sampling points. Take repeated sampling from all points until no contamination is found
- (2) Engine oil dipstick/ filler cap- CHECK oil level, then check filler cap secure. Prior to oil check turn the propeller several times by hand to pump oil from the engine into the oil tank, or let the engine idle for 1 min. This process is finished when air is returning back to the oil tank and can be noticed by a murmur from the open oil tank. **WARNING** –Do not stand within the arc of the propeller, check ignition off, throttle closed and park brake set before rotating the propeller by hand.
- (3) Carburetor and air filter – CHECK security
- (4) Radiator fluid over -flow bottle – CHECK fluid level
- (5) Propeller and spinner – CHECK for nicks, dents and security
- (6) Engine cooling air inlets and oil cooler – CHECK of obstructions
- (7) Engine cooling air outlet, radiator – CHECK of obstructions
- (8) Exhaust – CHECK – loose, damage

6 Right Wing

- (1) Main wheel tire – CHECK for proper inflation
- (2) Main Wheel – CHECK security, brake
- (3) Fuel quantity – CHECK visual for desired level
- (4) Fuel filler cap – CHECK secure
- (5) Forward lift strut and jury strut - CHECK security, dents, nicks
- (6) Wing Tie Down - DISCONNECT
- (7) Leading edge – CHECK condition, dents, nicks
- (6) Wing tip – CHECK security
- (7) Fabric (Surface) - CHECK - for rips, tears, damage

7 Right wing- Trailing Edge

- (1) Aileron – CHECK freedom of movement and security
- (2) Flap – CHECK security
- (3) Rear strut and jury strut attach – CHECK security, dents, nicks
- (4) Fabric (Surface) - CHECK - for rips, tears, damage

BEFORE STARTING THE POWERPLANT

- (1) Preflight Inspection - COMPLETE.
- (2) Passenger Briefing - COMPLETE.
- (3) Seat, seat belts - ADJUST and LOCK.
- (4) Brakes - TEST and SET
- (5) Radio, Electrical Equipment - OFF
- (6) Circuit Breakers - CHECK IN
- (7) Fuel Selector Valve - ON.

STARTING THE POWERPLANT

COLD START

- (1) Throttle - CLOSED.
- (2) Choke - ON.
- (3) Master Switch - ON.
- (4) Propeller Area - CLEAR
- (5) Ignition Switch - START (release when engine starts).
- (6) Throttle adjust – IDLE smooth – up to 2000 RPM
- (7) Oil pressure - CHECK
- (8) Choke – OFF
- (9) Avionics master - ON.

HOT START

- (1) Throttle - CLOSED.
- (2) Choke - OFF.
- (3) Master Switch - ON.
- (4) Propeller Area - CLEAR.
- (5) Ignition Switch - START (release when engine starts)
- (6) Throttle adjust – IDLE smooth – up to 2500 RPM
- (7) Oil pressure - CHECK
- (8) Avionics master - ON.

TAXIING

- (1) Brakes - CHECK.

BEFORE TAKEOFF

- (1) Cabin Doors - CLOSED OR SECURED.
- (2) Parking Brake - SET.
- (3) Flight Controls - FREE and Correct.
- (4) Flight Instruments - SET.
- (5) Elevator Trim - SET FOR TAKEOFF (center of indicator)
- (6) Fuel Selector Valve - ON
- (7) Fuel Quantity - CHECK
- (8) Throttle – 4000 RPM
 - a. Magneto - CHECK (Magneto drop should not exceed 300 RPM on either Magneto and the differential between magneto's should not be more than 120 RPM).
 - b. Engine Instruments and Voltmeter- CHECK
 - c. Carburetor heat – CHECK – RPM drop
- (9) Throttle – IDLE – adjust friction lock
- (10) Choke - OFF.
- (11) Radios - SET.
- (12) Fuel pump - ON
- (13) Wing flaps – SET for take off
- (14) Brakes - RELEASE

TAKEOFF

NORMAL TAKEOFF

- (1) Flaps – UP or HALF.
- (2) Carburetor heat – COLD
- (3) Fuel pump - ON
- (4) Throttle – SLOWLY FULL OPEN.
- (5) Elevator Control - LIFT TAIL WHEEL
- (6) Climb Speed – 65 - 70 MPH

SHORT FIELD TAKEOFF

- (1) Flaps - HALF.
- (2) Carburetor heat - COLD
- (3) Fuel pump - ON
- (4) Brake - APPLY.
- (5) Elevator Control- FULL BACK
- (6) Throttle – FULL OPEN.
- (7) Brake - RELEASE.
- (8) Elevator Control – LIFT TAIL WHEEL
- (9) Climb Speed - 55 MPH until all obstacles are cleared.
- (10) Flaps - RETRACT slowly after reaching 60 MPH.

ENROUTE CLIMB

NORMAL CLIMB

- (1) Airspeed – 70-80 MPH.
NOTE:
If a maximum performance climb is necessary, use speeds shown in the maximum rate of climb table in Section 5.
- (2) Fuel pump - ON
- (3) Throttle - 5800 RPM for 5 minutes, 5500 RPM continuous

CRUISE

- (1) Throttle - 4500 to 5500 RPM (Maximum continuous setting).
- (2) Elevator Trim - adjust.
- (3) Fuel pump – OFF

APPROACH

- (1) Throttle - AS DESIRED.
- (2) Engine temperatures – MONITOR
- (3) Carburetor heat – FULL HEAT AS REQUIRED

BEFORE LANDING

- (1) Seat, Belts, Shoulder Harness - ADJUST.
- (2) Fuel pump – ON
- (3) Carburetor heat – FULL HEAT AS REQUIRED

LANDING**NORMAL LANDING**

- (1) Airspeed (on approach) – 66-70 MPH (flaps UP).
- (2) Flaps (on final) - AS REQUIRED (below 69 MPH)
- (3) Airspeed (on final) - 64 MPH (with full flaps)
- (4) Touchdown - MAIN WHEELS FIRST OR THREE WHEEL
- (5) Landing Roll - LOWER TAIL WHEEL GENTLY (AFTER MAIN WHEEL TOUCH DOWN).
- (6) Brake - MINIMUM REQUIRED

SHORT FIELD LANDING

- (1) Airspeed (approach) – 66-70 MPH (flaps UP).
- (2) Flaps (on final) – FULL (below 69 MPH)
- (3) Airspeed - MAINTAIN 59 MPH .
- (4) Power - REDUCE to idle as obstacle is cleared
- (5) Touchdown - THREE WHEEL
- (6) Brake - APPLY as required
- (7) Wing Flaps - RETRACT for maximum brake effectiveness

BALKED LANDING

- (1) Throttle – FULL OPEN
- (2) Carburetor heat – COLD
- (3) Airspeed – 55 MPH
- (4) Wing Flaps – RETRACT TO HALF, Slowly
- (5) Airspeed – 60 MPH
- (6) Wing flaps – RETRACT, Slowly

AFTER LANDING

- (1) Wing Flaps - UP.
- (2) Taxi - SLOWLY.
- (3) Carburetor Heat- OFF.
- (4) Fuel pump - OFF

SECURING THE AIRCRAFT

- (1) Parking Brake - SET
- (2) Throttle - IDLE.
- (3) Radio and Electrical Equipment - OFF
- (4) Master Switch - OFF
- (5) Ignition - OFF.
- (6) Control Stick - SECURED
- (7) Aircraft - SECURELY TIED DOWN

AMPLIFIED-PROCEDURES

PREFLIGHT INSPECTION

The importance of thorough preflight cannot be over-emphasized. Develop a systematic, habitual approach. The use of good, sound, reasonable judgment in tandem with the preflight checklist is essential. Ensure "yourself", all parts and components, and the entire aircraft are in an airworthy condition before attempting flight.

Refer to **FIGURE 10-08**. Starting at the nose, work around the Rans S-7S aircraft in a clockwise manner as illustrated.

NOTE: This suggested outline for a preflight inspection generally covers the critical areas that **MUST** be checked prior to each flight. In addition, **EVERY** component should be examined, properly maintained, correctly stored or transported, and inspected before each flight to ensure structural integrity and proper flying characteristics.

NEVER use the brake as a parking brake with the intention of leaving the aircraft unattended. The S-7S is a light aircraft!

TAXING (Ground Handling)

The S-7S is a tail wheel aircraft. Concentrate on taxiing till the moment you tied the aircraft down.

When taxiing, it is important that speed and use of brakes is held to a minimum and that all controls are utilized to maintain directional control and balance as shown in **FIGURE 10-09**.

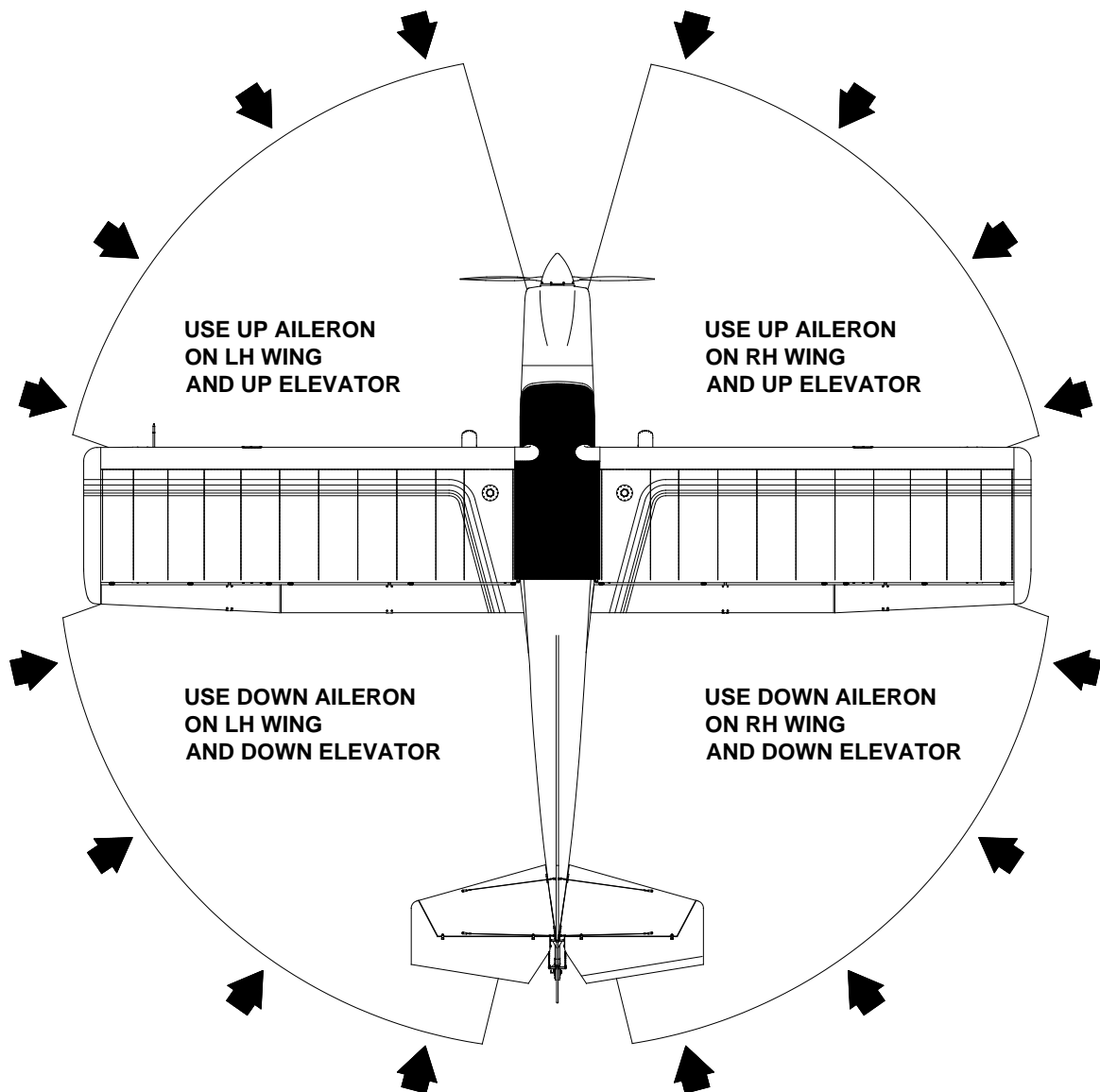

FIGURE 10-09. Taxiing Diagram

The arrows identify the wind direction. It is very important to hold the controls as described, even when the aircraft is not moving. When taxiing in strong crosswinds a little extra throttle will help the aircraft turn due to the increased airflow over the rudder. Caution should be used not to use excessive throttle, sudden throttle movements or excessive braking.

The S-7S is equipped with a steerable full swivel tail wheel. To taxi very small radius turns, push the desired rudder pedal and the brake pedal in the same direction. This will disengage the steering cam and will allow the tail wheel to swivel 360 degree. To reengage use opposite rudder and brake to stop turn and roll a few feet straight forward.

Prior to commencing the takeoff roll, align the aircraft in the intended direction of takeoff and allow it to roll forward a few feet to straighten tail wheel and to assure the steer-cam is engaged -before applying full power. This prevents possible harmful side-loading of the tail wheel.

FLAP SETTINGS

Normal takeoffs are accomplished with flaps up or half. Using half flaps reduces the ground roll and the total distance to clear an obstacle. If half flaps are used for takeoff, they should be left in that position until all obstacles are cleared and a flap retraction speed of 60 MPH is reached.

SECURING THE AIRCRAFT

If the aircraft must be left unattended outdoors, always secure it with tie-downs.

NEVER use the brake as a parking brake with the intention of leaving the aircraft unattended. The S-7S is a light aircraft!

The type of tie-downs used is a matter of personal choice. A good "rule-of-thumb" is to ensure that what you secure the aircraft to (and with) will restrain at least 1200 lbs at each tie-down location. Secure the controls in the cockpit and use the following tie down points:

- Tail gear
- Left forward wing strut (top- closed to wing attach)
- Right forward wing strut (top-closed to wing attach)

If strong winds or gusts are advised seek shelter for the AC.

HOT WEATHER OPERATION

Avoid prolonged engine operation on the ground.

Turn the airplane in to the wind to assure airflow through the cowling during run up.

Monitor engine temperatures and adjust climb speed as required. A higher climb speed will provide better engine cooling.

S-7S EMERGENCY PROCEDURES

INTRODUCTION

This section provides checklists and amplified procedures for coping with emergencies that may occur. Emergencies caused by aircraft or powerplant malfunctions are rare if proper preflight inspections and maintenance are performed. Emergencies caused by extreme weather situations can be minimized or eliminated by good judgment and proper preflight planning. However, should an emergency arise the basic guidelines described in this section should be considered and applied as necessary to resolve the problem.

In any emergency – fly the airplane first - maintain control.

The following material is provided for guidance only.

AIRSPEEDS FOR EMERGENCY OPERATION (IAS)

| | | |
|--|------------|--------|
| Engine Failure After Takeoff | Flaps UP | 66 MPH |
| | Flaps DOWN | 59 MPH |
| Maneuvering Speed | | 97 MPH |
| Maximum Glide | Flaps UP | 64 MPH |
| Precautionary Landing with Engine Power | Flaps UP | 59 MPH |
| | Flaps DOWN | 55 MPH |
| Landing without Engine Power | Flaps UP | 70 MPH |
| | Flaps Down | 65 MPH |

OPERATIONAL CHECKLISTS

ENGINE FAILURE

Engine Failure During Takeoff Run:

Fly the Airplane!

- (1) Throttle - IDLE.
- (2) Brakes - APPLY as needed.
- (3) Ignition switch - OFF.
- (4) Master switch - OFF.

Engine Failure Immediately After Takeoff

Fly the Airplane!

- (1) Airspeed - 66 MPH (Flaps up).
59 MPH (Flaps down).
- (2) Brakes - APPLY As Needed.
- (3) Ignition Switch - OFF.
- (4) Master Switch - OFF.

Engine Failure During Flight

Fly the Airplane!

- (1) Airspeed - 64 MPH for best glide
- (2) Select Emergency Landing Area - PROCEED To It.
- (3) Attempt Engine RESTART.
- (4) Ignition - Check ON.
- (5) Choke - Check OFF.
- (6) Throttle Lever - CRACKED (approximately 1/4" forward).
- (7) Turn Switch to START
- (8) If Engine **DOES NOT** Start - Follow Emergency Landing Procedure Without Engine Power.

FORCED LANDINGS

Emergency Landing Without Engine Power

Fly the Airplane!

- (1) Flaps - As REQUIRED for Landing Site.
Airspeed - 70 MPH (Flaps up).
65 MPH (Flaps down).
- (2) Fuel Selector Valve - OFF.
- (3) All Switches - OFF.
- (4) Unlatch cabin doors prior final approach
- (5) Touchdown - MINIMUM FLIGHT SPEED.
- (6) Brakes - APPLY As Needed.

Precautionary Landing With Engine Power

Fly the airplane!

- (1) Select Field - FLY OVER, noting terrain, obstructions and wind direction.
- (2) Flaps - AS REQUIRED (for landing site).
- (3) Airspeed 59 MPH (Flaps UP).
55 MPH (Flaps full DOWN) (Use flaps as required for landing site).
- (4) Master Switch - OFF.
- (5) Doors - OPEN.
- (6) Touchdown - MINIMUM FLIGHT SPEED.
- (7) Ignition - OFF.
- (8) Brakes - APPLY As Needed.

FIRES

During Start On Ground

- (1) Cranking - CONTINUE, to get a start which would suck the flames and accumulated fuel through the carburetor and into the engine.
If Engine Starts:
- (2) Power – 4500 -5000 RPM for a few minutes.
- (3) Engine - SHUTDOWN and inspect for damage.
If Engine fails to Start:
- (4) Continue cranking with throttle full open while ground attendants obtain fire extinguisher; when ready to extinguish fire -
- (5) Ignition - OFF.
- (6) Master Switch - OFF.
- (7) Fuel Selector Valve - OFF.
- (8) Fire Damage - INSPECT, repair damage or replace damaged components or wiring before conducting another flight.

Engine Fire In Flight

Fly the airplane!

- (1) Fuel Selector Valve - OFF.
- (2) Ignition switch- OFF.
- (3) Master switch - OFF.
- (4) Cabin heat - OFF.
- (5) Airspeed - 95 MPH (If fire is not extinguished, increase glide speed to find an airspeed which will provide an incombustible mixture (CAUTION DO NOT EXCEED VNE).
- (6) Forced Landing - EXECUTE (as described in Emergency Landing Without Engine Power).

Electrical Fire In Flight

Fly the airplane!

- (1) Master Switch - OFF .
- (2) All Other Switchs (except Ignition switch) OFF.
If fire appears out and electrical power is necessary for continuance of flight:
- (3) Circuit Breakers - CHECK for faulty circuit, do not reset faulty circuit
Master Switch - ON.
- (4) Radio/Electrical Switches - ON one at a time, with delay after each until short circuit is localized.

RECOVERY FROM A SPIRAL DIVE

If a spiral dive is encountered, proceed as follows:

- (1) Retard Throttle to **IDLE**.
- (2) Stop the turn by using coordinated aileron and rudder in opposite direction of spiral dive.
- (3) Cautiously apply elevators back pressure to slowly reduce the airspeed to below maneuvering speed .

SPINS

Intentional spins in the S-7S aircraft are not recommended. Should an inadvertent spin occur, the following recovery procedure should be used:

- (1) Retard the throttle to **IDLE**.
- (2) Place the ailerons in the **NEUTRAL** position.
- (3) Apply and **HOLD** full rudder opposite to the direction of rotation.
- (4) Just after the rudder pedal reaches the stop, move the control stick (yoke) forward far enough to "break" the stall.
- (5) Hold these control inputs until rotation stops.
- (6) As rotation stops, neutralize rudder and apply back pressure on the control stick to slowly reduce airspeed to normal cruise speed.

AMPLIFIED PROCEDURES

ENGINE FAILURE

If an engine failure occurs during the takeoff run, the most important thing to do is to stop the aircraft on the remaining runway. Those extra items on the checklist will provide added safety during a failure of this type.

The first response to an engine failure, after takeoff, is to promptly **LOWER** the nose and establishes a glide attitude (check and maintain speed). In most cases, the landing should be planned straight ahead with only small heading corrections to avoid obstructions. Of course, the number one priority is to land the aircraft as smoothly and accurately as possible. **Altitude and airspeed are seldom sufficient to execute a 180-degree gliding turn back to the runway.**

After an engine failure in flight, the best glide speed (64 mph) should be established as quickly as possible. While gliding toward a suitable landing site, an effort should be made to identify the cause of the failure. If time permits, an engine restart should be attempted as shown on the checklist. If the engine cannot be restarted, a forced landing without power must be completed.

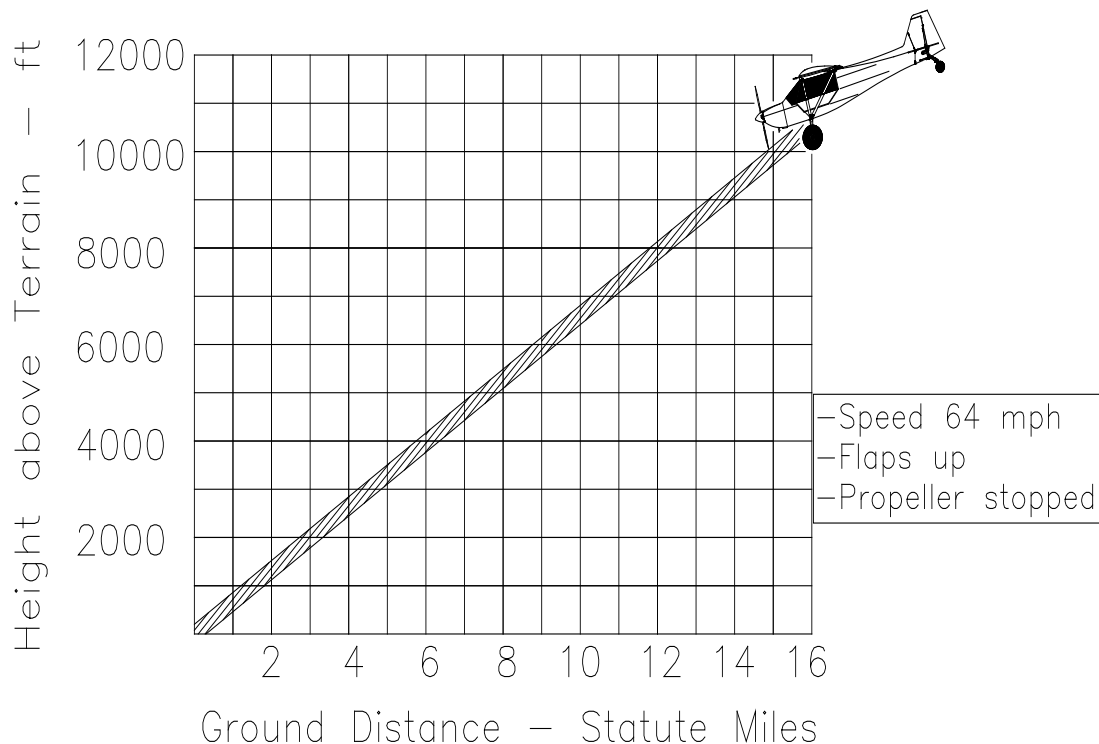

FIGURE 10-10. Maximum Glide

FORCED LANDINGS

Select a suitable landing site and proceed to it. If all attempts to restart the engine fail and a forced landing is imminent, follow the checklist for Emergency Landing Without Power.

Before attempting an off airport landing with engine power available, fly over the landing site at a safe but low altitude to inspect the terrain. Check for obstructions and surface conditions. Plan your approach and touch down.

When preparing to ditch, it is advisable to jettison any heavy objects from around the Pilot, including heavy clothing. Of course, if time permits, ditch as close to land or a water vessel as possible.

Transmit Mayday message on 121.5 MHz giving location and intentions.

RECOVERY FROM A SPIRAL DIVE

If a spiral dive is encountered, proceed as follows:

- (1) Retard Throttle to **IDLE**.
- (2) Stop the turn by using coordinated aileron and rudder in opposite direction of spiral dive.
- (3) Cautiously apply elevator back pressure to slowly reduce the airspeed to below maneuvering speed .

SPINS

Intentional spins in the S-7S aircraft are **PROHIBITED**. Should an inadvertent spin occur, the following recovery procedure should be used:

- (1) Retard the throttle to **IDLE**.
- (2) Place the ailerons in the **NEUTRAL** position.
- (3) Apply and **HOLD** full rudder opposite to the direction of rotation.
- (4) Just after the rudder pedal reaches the stop, move the control stick (yoke) forward far enough to "break" the stall.
- (5) Hold these control inputs until rotation stops.
- (6) As rotation stops, neutralize rudder and apply back pressure on the control stick to slowly reduce airspeed to normal cruise speed.

IGNITION MALFUNCTION

A sudden engine roughness or misfiring is usually evidence of ignition problems. Switching from BOTH to either L or R ignition switch position will identify which circuit is malfunctioning. Select different power settings if continued operations on BOTH circuits is practicable. If not, switch to the good circuit and proceed to the nearest airport for repairs.

CARBURETOR ICE

A sudden engine roughness or loss of rpm could be Carburetor Ice problems. Actuate the Carburetor Ice by pulling on the Carburetor Ice Control Knob.

As soon as the engine roughness or suspected carburetor ice is gone turn off the Carburetor Heat. Repeat as necessary.

DOORS

The S-7S is equipped with two doors, one on each side of the AC. Always secure the doors before flight. Only 1 door may be open in flight. Open at or below 60 mph. Do not exceed 100 mph.

If a door comes open in flight, fly the AC before you attempt to close it. The AC will fly with open doors. The door will float in a position pending on the speed of the AC. To close an open door in flight, slow to 60 mph, push the opposite rudder pedal. This will make the AC yaw and help to get the door closed.

S-7S AIRCRAFT CARE

INTRODUCTION

If your airplane is to retain that new airplane performance and dependability, certain inspection and maintenance requirements must be followed. It is recommended to follow a planned schedule of lubrication and preventive maintenance based on the climatic and flying conditions encountered.

GROUND HANDLING

On the ground the aircraft is most easily maneuvered by hand at the leading edge handles of the horizontal stabilizer. The aircraft has a 360-degree full swivel tail wheel, which is connected to the rudder by a centering cam. You can disengage the tail wheel through pushing sideways on the rear fuselage (upper longerons) and allow it to swivel freely in any direction. This will help you to maneuver the aircraft in tight spaces.

WINDSHIELD AND WINDOWS

The windshield and windows are made from Lexan. **Do not bring in contact with fuel. Fuel will harm these surfaces almost immediately.** If fuel is spilled accidentally, wipe off with lots of water.

Always close the doors when you re-fuel the AC. Otherwise, it is possible that spilled fuel may run around the wing trailing edge and drop on the open door.

Clean the windshield with plenty of water and if you need to, with a mild detergent in low concentration. Rinse thoroughly and dry with a clean soft cloth or towel.

We recommend "Brillianize" for windshield care. Brillianize is available through RANS' Parts Department.

CAUTION: Never use gasoline, benzene, alcohol, acetone, thinner or glass cleaner on Lexan surfaces (windows).

PAINTED SURFACES

The painted exterior surfaces of your S-7S aircraft have a durable and long lasting finish. No polishing or buffing will be required under normal conditions.

It is recommended to keep your aircraft out of the sun as much as possible. If you keep your aircraft outside it is recommended to wax the exterior surface.

It is also recommended to clean the exterior surface of your airplane on a regularly base. This can also be accomplished with "Brillianize". It is possible to wash the airplane carefully with water and a mild soap, followed by a rinse with water and drying with a soft cloth.

INTERIOR CARE

Use a vacuum cleaner to remove dust and loose dirt from the interior and upholstery. Household spot removers or upholstery cleaner may also be used for the seat upholstery. Always test it on an obscure place on the fabric to be cleaned.

The plastic baggage enclosure can be cleaned with a damp cloth and an automotive plastic interior care.

The instrument panel, control knobs need only be wiped of with a damp cloth.

S-7S WINTERIZATION KIT

(REFER TO PARTS PAGE # 011-02 FOR PARTS SELECTION)

The winterization kit consists of partial covers for oil cooler and radiator.

After the initial installation is completed, further installations or removals are possible without cowling removal.

Note: The winterization kit should be removed if the outside air temperature exceeds 55 F.

Refer to the parts manual and install as shown. Note: The oil cooler cover mount plate and the radiator cover mount plates are permanent installed.

S-7S WHELEN STROBE INSTALLATION

(REFER TO PARTS PAGE # 011-06 FOR PARTS SELECTION)

STROBE POWER BOX INSTALLATION

(AFTER PAINTING OF FUSELAGE – DURING FINAL ASSEMBLY)

Refer to **FIGURE 11B-01**

Position cushioned tube clamps on the Station 3 lower crossing tube and lower diagonal tube. See **FIGURE 11B-01**. Position the forward clamp about 1” inboard of the seat support tube and bolt the tang to the clamp. **NOTE:** *Leave the bolt loose to ease moving the clamp.*

Position the power box with the power connections to the aft. Bolt the strobe power box to the tang. Position the clamps to line up with the power box mounting holes and bolt. Tighten all bolts.

STROBE / POSITION LIGHT WIRING INSTALLATION

(BEFORE COVERING OF WINGS)

NOTE: *Installation may also be done on covered wings.*

Unroll the gray strobe wire and cut it in half. Cut four 20’ segments of 14-gauge wire. Run the gray and 14-gauge wire through the trailing edge spar to the wing tip bow. Secure the wires for covering to the inboard side of the wing tip bow, approximately 13” aft of the leading edge. Be certain to leave enough length to work with while wiring.

(AFTER WING TO FUSELAGE ATTACHMENT)

Connect the ends, provided in the strobe kit, to the three (3) wires coming out of the gray strobe cable. The Whelen Installation Manual has directions about which way they go on. **NOTE:** *Cut to length and connect the wires after bolting the wings on.* Red connects to #1, black connects to #2, and white connects to #3. Make sure these ends are inserted all the way into the connector. The unprotected wire (shield) connects to the aircraft ground buss. The two white connectors, from the gray strobe cable, are plugged into the strobe outlets on the power box.

Run a 14-gauge wire from the NAV switch back to the strobe box area. Connect a brass "Y" to the end of the wire. The 14-gauge wire coming out of each wing will connect to the "Y". **NOTE:** *Wrap the "Y" with electrical tape, after connection, to prevent shorting.* Run a 14-gauge wire from the strobe switch back to the strobe box. Also, run a 14-gauge wire for the ground buss. Connect these wires to the black and red wires coming out of the strobe box. **NOTE:** Remember to connect the ground wire to the strobe shield wires. Check all connections and wires.

STROBE / POSITION LIGHT INSTALLATION

(BEFORE PAINTING OF WING TIPS)

Refer to **FIGURE 11B-02**

Rivet the Navigation Light Mount to the wing tip per **FIGURE 11B-02**. Use the nutplate rivets to retain the mount plate. Drill the three (3) mounting holes in each Strobe Light Assembly to #11. Trial fit.

(AFTER PAINTING OF WING AND PRE-INSTALLATION OF WING TIPS)

Refer to **FIGURE 11B-03**

Secure Strobe / Navigation Light to wing tip. Cut out the 4" inspection panel in outer wing skin. Pull wires taped to inside of tip bow through inspection hole. Connect plastic plugs from strobe and gray wire. Secure connector with electrical tape or plastic tie wrap to prevent disconnection.

Connect Red and Blue Power wires from NAV lights to 14-gauge NAV power wire. Ground the Black and Blue Ground wires from the NAV lights back to the Ground Buss. Install Wing Tip. Check Strobe and NAV lights for proper operation.

S-7S SENSENICH COMPOSITE PROP INSTALLATION

(REFER TO PARTS PAGE # 011-08 FOR PARTS SELECTION)

Refer to **FIGURES 06-13, 06-14, 06-15** and **11C-01**.

Install the flange bushings into the prop flange on the engine from the aft side. Use a "C" clamp to completely seat the bushings into the flange. Place a small wood block between the pad of the clamp and the aluminum bushing to protect them from being damaged. Use a piece of tubing approximately 1" long over the flange bushings to allow them to seat as the "C" clamp is tightened. See **FIGURE 06-13**.

Inspect the prop for any nicks, cracks, or dings.

Mount the propeller as per parts drawing and information provided with the prop. Note the length of the bolts is critical. Use washers to be certain the bolts are not bottomed out on the threads. **DANGER:** *If bolts are bottomed out on the threads, the prop is not properly torqued, separation from the aircraft during operation may occur.* Torque the bolt from 180 to 200 inch pounds in the pattern shown in **FIGURE 06-14**. Re-torque bolts after 5 hours of flight and thereafter according to manufacturer's instructions.

Check prop for tracking by turning blade into a vertical position and placing an object at the tip. Pull the prop to the next blade and check position. If the position is the same the prop is in track. If not, loosen prop bolts and re-torque until proper tracking is achieved. **HINT:** *Start torque pattern on the blade that is out of track.* See **FIGURE 06-15**. **DANGER:** *Track prop with ignition OFF!!*

Using the template from **FIGURE 11C-01**, mark and cut out the openings in the spinner dome.

Drill and install the spinner dome to the backing plate. Refer to **SECTION 06 – SPINNER** and **PROPELLOR INSTALLATION** sections.

When servicing your propeller, refer to:

SENENICH PROPELLER CO., INC.

**EZ-PITCH COMPOSITE AIRCRAFT PROPELLER INSTALLATION AND
OPERATION INSTRUCTIONS.**

DOC#: COMP-AC-CF (Adjustable Pitch)

Propellers:

Propeller Manufacturer: Sensenich propeller Inc.
Propeller Model Number: 2A1R5R70D(N)*
Number of Blades: 2
Propeller Diameter: 70"
Propeller Type: 2 blade, adjustable pitch

* An (N) at the end of the part number denotes a nickel leading edge.

Best adjustment is normally just under #4 on the prop hub index. This should yield a ground static of about 5400 RPM.

Final setting will be determined during flight testing.

S-7S WARP DRIVE PROP INSTALLATION

(REFER TO PARTS PAGE # 011-10 FOR PARTS SELECTION)

Refer to **FIGURES 06-13, 06-14, 06-15** and **11D-01**.

Install the flange bushings into the prop flange on the engine from the aft side. Use a "C" clamp to completely seat the bushings into the flange if needed. Place a small wood block between the pad of the clamp and the aluminum bushing to protect them from being damaged. Use a piece of tubing approximately 1" long over the flange bushings to allow them to seat as the "C" clamp is tightened. See **FIGURE 06-13**.

Inspect the prop for any nicks, cracks, or dings.

Mount the propeller as per parts drawing and information provided with the prop. Note the length of the bolts is critical. Use washers to be certain the bolts are not bottomed out on the threads. **DANGER:** *If bolts are bottomed out on the threads, the prop is not properly torqued, separation from the aircraft during operation may occur.* Adjust the blade angle and torque the 1/4" bolts retaining the blades to 120 inch-pounds. Torque the 5/16" bolts to 200 inch-pounds in the pattern shown in **FIGURE 06-14**. **NOTE:** *Check the specifications provided with the prop for torque updates.* Re-torque bolts after 5 hours of flight and thereafter according to manufacturer's instructions.

Check prop for tracking by turning blade into a vertical position and placing an object at the tip. Pull the prop to the next blade and check position. If the position is the same, the prop is in track. If not, loosen prop bolts and re-torque until proper tracking is achieved. **HINT:** *Start torque pattern on the blade that is out of track.* See **FIGURE 06-15**.

DANGER: *Track prop with ignition **OFF!!***

Using the template from **FIGURE 11D-01**, mark and cut out the openings in the spinner dome.

Drill and install the spinner dome to the backing plate. Refer to **SECTION 06 – SPINNER** and **PROPELLOR INSTALLATION** sections.

Best adjustment is normally about 13 degrees at the prop tip. This should yield a ground static of about 5400 RPM.

Final setting will be determined during flight testing to yield about 5600 RPM in level flight at full throttle.

S-7S WHIRL WIND PROP INSTALLATION

1. Using the template from **FIGURE 11E-01**, mark and cut out the openings in the spinner dome.
2. Drill and install the spinner dome to the backing plate. Refer to **SECTION 06 – SPINNER** and **PROPELLOR INSTALLATION** sections.
3. Install the flange bushings into the prop flange on the engine from the aft side. If needed, use a “C” clamp to completely seat the bushings into the flange. Place a small wood block between the pad of the clamp and the aluminum bushing to protect them from being damaged. Use a piece of tubing approximately 1" long over the flange bushings to allow them to seat as the “C” clamp is tightened. See **FIGURE 06-13**.
4. Inspect the prop for any nicks, cracks, or dings.
5. Mount the propeller as per parts drawing and information provided with the prop. Note the length of the bolts is critical. Use washers to be certain the bolts are not bottomed out on the threads. **DANGER: If bolts are bottomed out on the threads, the prop is not properly torqued, separation from the aircraft during operation may occur.**
6. Install Spinner Backing Plate and bolt the prop assembly in place. Set prop angle and torque to manufacturer's specifications. Best adjustment is normally about 17 degrees. This should yield a ground static of about 5400 RPM.
7. Torque the retaining bolts to manufacturer specs in the pattern shown in **FIGURE 06-14**. **NOTE: Check the specifications provided with the prop for torque updates.** Re-torque bolts after 5 hours of flight and thereafter according to manufacturer's instructions.
8. Check prop for tracking by turning blade into a vertical position and placing an object at the tip. Pull the prop to the next blade and check position. If the position is the same, the prop is in track. If not, loosen prop bolts and re-torque until proper tracking is achieved. **HINT: Start torque pattern on the blade that is out of track.** See **FIGURE 06-15**.

DANGER: Track prop with ignition OFF!!

9. Final setting will be determined during flight testing to yield about 5400 - 5600 RPM in level flight at full throttle.